



Classic Collection has every length, width and height imaginable in every color.

CHOICES

- a) Colors – We'll build in any manufacturer's laminate, any color, any style.
- b) Customization – We create one-of-a-kind items to make your installation complete.
- c) Single Source – Get all your furniture through one source. We have desk, workstations, lecterns, study carrels, & conference tables. You name it, we build it.

FLEXIBILITY

- a) Modularity – Worksurfaces up to 120" long. Pedestals for all types of storage
- b) Custom Fit – For smaller personal spaces to the wide open range. Surfaces can be cut to length to efficiently fit the space.
- c) Growth – The smart way to grow business. Start out with a few pieces. Then add a few more.

FUNCTIONALITY

- a) Adaptable Edges – Straight edges abut easily for smooth continuous worksurfaces.
- b) Wire Management – Lots of grommets to route cords. For helpful alternative, order without back panel for complete wire access.
- c) Shapes – Lots of shapes to choose from. Shapes for interaction. Shapes for private meetings. Shapes to support technology.

DURABILITY

- a) Durable Edges – Won't scratch, nick or ding. Withstands even the toughest days on the job.
- b) HPL Vertical Surfaces – Surface resist nicks and scratches to battle wayward mobile pedestals.
- c) Easy to Clean – Just wipe with a damp cloth or mild household cleaner.



Classic Collection



L.U.I.+PLUS

The Classic Collection Desk Specifications

- Top & End Panels** 1 1/8" particle board covered on all surfaces with a high pressure laminate.

- Front End Panels** 3/4" particle board covered on exterior surfaces with high pressure laminate.

- Drawers** All wood construction. All exposed surfaces covered with black vinyl. All drawers open by finger pulls, which is from the side.

- File Drawers** Mounted on full extension progressive slides. Metal suspension supplied for hanging file folders. Accommodates letter or legal size

- Box Drawers** Mounted on full extension progressive slides.

- Doors** All L.U.I.+PLUS Single and Double Door Storage Units, feature concealed hinges and touch latch opening for clean design and easy operation.

- Finishes** Standard Finishes by **FORMICA & WILSON ART**
10% upcharge for **NEVEMAR** and **PIONITE** laminates

- Leveling Glides** Supplied on all units. Glides are adjustable.

- Keying** Standard production is to random key all units.

- Keying Alike** Units that are needed keyed alike should be specified on order (NO UPCHARGE)

- Master Keying** Is available on any number of units up to 50 different keys with 1 master key. Master keying should be specified, upcharge \$51 (Master Keys are not shipped with furniture, but sent to ordering dealer or designated agent.)

Classic 2

NOTE: Any desk or return with a file drawer comes standard with lock.

Recessed Front Model

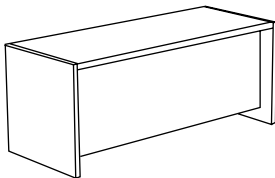

Flush Front Model

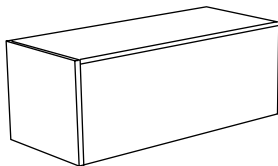

Recessed to Floor Model

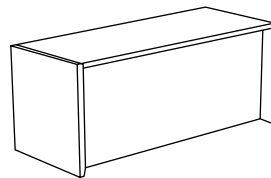



Classic Collection

Edge

Finishes

L.U.I.+PLUS Products are finished in high pressure laminate using the most modern machinery and techniques available.

Pricing

Prices shown in this price book reflects use of solid colors & woodgrains as many manufactured in standard "textured" finish

by: **WILSON ART** and **FORMICA**, add 10% upcharge for **NEVEMAR** and **PIONITE** laminates.

Specifying of two finishes on a unit may result in an upcharge. Consult factory. 1-800-638-4111

Other laminate manufacturers may be subject to an upcharge. Consult factory. 1-800-638-4111

Availability

Standard Finishes by **FORMICA & WILSON ART** are readily obtainable and expedite delivery.

Other manufacturer's material may delay shipment and result in an upcharge. Consult when specifying these materials.

Finish Types

Textured - The most commonly used material and the L.U.I.+PLUS standard. Unless otherwise noted, all products are available in this finish.

Gloss- A high sheen, glass-like highly susceptible to scratching. Consult factory upcharge. 1-800-638-4111

General Information

L.U.I.+PLUS does not manufacture laminate. You are requested to refer to laminate manufactures literature for complete specifications of product. All dimensions are approximate and through manufacturing process may vary.

EDGE TREATMENT

Self -Edge furniture is finished in laminate edge

VINYL BUMPER

To designate finish for bumper edge, put one of the below abbreviations with your finish selection on your purchase order.

- Dark Walnut**.....D01
- Medium Oak**.....D05
- Mahogany**.....D29
- Black**.....D03
- Light Grey**.....D31
- Putty**.....D04
- Cream**.....D20

FABRIC

Standard fabric selections for tackpanels are list below. There is no additional cost.

Guilford of Maine

- | | |
|----------------------------|------------------------|
| Bailey - Style 2229 | Hopscotch - Style 2823 |
| Grille - Style 2822 | Belgrade- Style 4052 |
| Orissa - Style 2818 | FR701-Style 2100 |
| Donegal Tweed - Style 3102 | |

To specify a fabric on your order please indicate group, group# and color#

Classic 3



Classic Collection

Edge

SERIES 200 - The Classic Collection Double Pedestal Desk

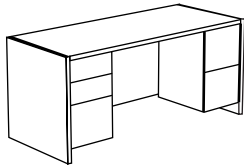

D	W	Recessed Front #	Flush Front #	Recessed to Floor #	Zone 0	Zone 1	Zone 2	WT
36"	72"	2L62-CD	25L62-CD	21L62-CD	\$2,745	\$3,013	\$3,174	465
30"	72"	2L02-CD	25L02-CD	21L02-CD	\$2,614	\$2,882	\$3,043	408
36"	66"	2L66-CD	25L66-CD	21L66-CD	\$2,614	\$2,882	\$3,043	420
30"	66"	2L06-CD	25L06-CD	21L06-CD	\$2,575	\$2,842	\$3,003	384
36"	60"	2L60-CD	25L60-CD	21L60-CD	\$2,601	\$2,881	\$3,029	378
30"	60"	2L00-CD	25L00-CD	21L00-CD	\$2,444	\$2,711	\$2,872	360

LEFT - Box/box/file - Pedestal
RIGHT - File/file - Pedestal

Locking
SHIPS FULLY ASSEMBLED

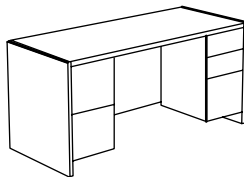

D	W	Recessed Front #	Flush Front #	Recessed to Floor #	Zone 0	Zone 1	Zone 2	WT
36"	72"	2L62-DC	25L62-DC	21L62-DC	\$2,745	\$3,013	\$3,174	465
30"	72"	2L02-DC	25L02-DC	21L02-DC	\$2,614	\$2,882	\$3,043	408
36"	66"	2L66-DC	25L66-DC	21L66-DC	\$2,614	\$2,882	\$3,043	420
30"	66"	2L06-DC	25L06-DC	21L06-DC	\$2,575	\$2,842	\$3,003	384
36"	60"	2L60-DC	25L60-DC	21L60-DC	\$2,601	\$2,881	\$3,029	378
30"	60"	2L00-DC	25L00-DC	21L00-DC	\$2,444	\$2,711	\$2,872	360

LEFT - File/file - Pedestal
RIGHT - Box/box/file - Pedestal

Locking
SHIPS FULLY ASSEMBLED

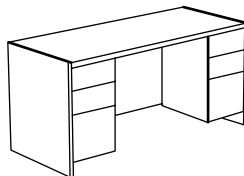

D	W	Recessed Front #	Flush Front #	Recessed to Floor #	Zone 0	Zone 1	Zone 2	WT
36"	72"	2L62-CC	25L62-CC	21L62-CC	\$2,745	\$3,013	\$3,174	465
30"	72"	2L02-CC	25L02-CC	21L02-CC	\$2,614	\$2,882	\$3,043	408
36"	66"	2L66-CC	25L66-CC	21L66-CC	\$2,614	\$2,882	\$3,043	420
30"	66"	2L06-CC	25L06-CC	21L06-CC	\$2,575	\$2,842	\$3,003	384
36"	60"	2L60-CC	25L60-CC	21L60-CC	\$2,601	\$2,881	\$3,029	378
30"	60"	2L00-CC	25L00-CC	21L00-CC	\$2,444	\$2,711	\$2,872	360

LEFT - Box/box/file - Pedestal
RIGHT - Box/box/file - Pedestal

Locking
SHIPS FULLY ASSEMBLED

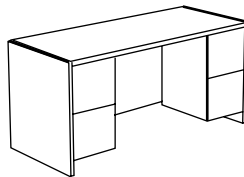

D	W	Recessed Front #	Flush Front #	Recessed to Floor #	Zone 0	Zone 1	Zone 2	WT
36"	72"	2L62-DD	25L62-DD	21L62-DD	\$2,745	\$3,013	\$3,174	465
30"	72"	2L02-DD	25L02-DD	21L02-DD	\$2,614	\$2,882	\$3,043	408
36"	66"	2L66-DD	25L66-DD	21L66-DD	\$2,614	\$2,882	\$3,043	420
30"	66"	2L06-DD	25L06-DD	21L06-DD	\$2,575	\$2,842	\$3,003	384
36"	60"	2L60-DD	25L60-DD	21L60-DD	\$2,601	\$2,881	\$3,029	378
30"	60"	2L00-DD	25L00-DD	21L00-DD	\$2,444	\$2,711	\$2,872	360

LEFT - File/file - Pedestal
RIGHT - File/file - Pedestal

Locking
SHIPS FULLY ASSEMBLED

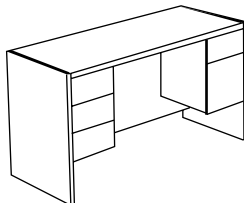

D	W	Recessed Front #	Flush Front #	Recessed to Floor #	Zone 0	Zone 1	Zone 2	WT
36"	72"	2M62-AB	25M62-AB	21M62-AB	\$2,745	\$3,013	\$3,174	444
30"	72"	2M02-AB	25M02-AB	21M02-AB	\$2,614	\$2,882	\$3,043	396
36"	66"	2M66-AB	25M66-AB	21M66-AB	\$2,614	\$2,882	\$3,043	408
30"	66"	2M06-AB	25M06-AB	21M06-AB	\$2,575	\$2,842	\$3,003	372
36"	60"	2M60-AB	25M60-AB	21M60-AB	\$2,601	\$2,881	\$3,029	366
30"	60"	2M00-AB	25M00-AB	21M00-AB	\$2,444	\$2,711	\$2,872	348

LEFT - Box/box/box - Pedestal
RIGHT - Box/file - Pedestal

Locking
SHIPS FULLY ASSEMBLED

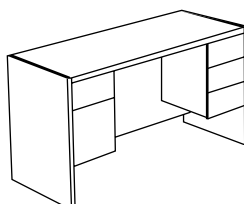

D	W	Recessed Front #	Flush Front #	Recessed to Floor #	Zone 0	Zone 1	Zone 2	WT
36"	72"	2M62-BA	25M62-BA	21M62-BA	\$2,745	\$3,013	\$3,174	444
30"	72"	2M02-BA	25M02-BA	21M02-BA	\$2,614	\$2,882	\$3,043	396
36"	66"	2M66-BA	25M66-BA	21M66-BA	\$2,614	\$2,882	\$3,043	408
30"	66"	2M06-BA	25M06-BA	21M06-BA	\$2,575	\$2,842	\$3,003	372
36"	60"	2M60-BA	25M60-BA	21M60-BA	\$2,601	\$2,881	\$3,029	366
30"	60"	2M00-BA	25M00-BA	21M00-BA	\$2,444	\$2,711	\$2,872	348

LEFT - Box/file - Pedestal
RIGHT - Box/box/box - Pedestal

Locking
SHIPS FULLY ASSEMBLED

Classic 4



Classic Collection

Edge

SERIES 200 - The Classic Collection Double Pedestal Desk

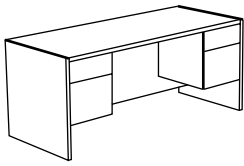

D	W	Recessed Front #	Flush Front #	Recessed to Floor #	Zone 0	Zone 1	Zone 2	WT
36"	72"	2M62-BB	25M62-BB	21M62-BB	\$2,470	\$2,738	\$2,898	444
30"	72"	2M02-BB	25M02-BB	21M02-BB	\$2,339	\$2,607	\$2,767	396
36"	66"	2M66-BB	25M66-BB	21M66-BB	\$2,431	\$2,698	\$2,859	408
30"	66"	2M06-BB	25M06-BB	21M06-BB	\$2,300	\$2,567	\$2,728	372
36"	60"	2M60-BB	25M60-BB	21M60-BB	\$2,326	\$2,593	\$2,754	366
30"	60"	2M00-BB	25M00-BB	21M00-BB	\$2,169	\$2,436	\$2,597	348

LEFT - Box/file - Pedestal

Locking

RIGHT - Box/file - Pedestal

SHIPS FULLY ASSEMBLED

SERIES 200 - The Classic Collection Single Pedestal Desk

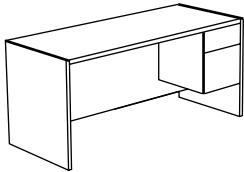

D	W	Recessed Front #	Flush Front #	Recessed to Floor #	Zone 0	Zone 1	Zone 2	WT
36"	72"	2M62-XB	25M62-XB	21M62-XB	\$1,973	\$2,134	\$2,296	390
36"	66"	2M66-XB	25M66-XB	21M66-XB	\$1,946	\$2,108	\$2,270	354
36"	60"	2M60-XB	25M60-XB	21M60-XB	\$1,842	\$2,003	\$2,165	312
30"	72"	2M02-XB	25M02-XB	21M02-XB	\$1,854	\$2,017	\$2,177	342
30"	66"	2M06-XB	25M06-XB	21M06-XB	\$1,828	\$1,990	\$2,152	318
30"	60"	2M00-XB	25M00-XB	21M00-XB	\$1,697	\$1,859	\$2,021	294
24"	72"	2M42-XB	25M42-XB	21M42-XB	\$1,645	\$1,806	\$1,968	249
24"	66"	2M46-XB	25M46-XB	21M46-XB	\$1,592	\$1,755	\$1,915	204
24"	60"	2M40-XB	25M40-XB	21M40-XB	\$1,514	\$1,675	\$1,837	174
24"	48"	2M48-XB	25M48-XB	21M48-XB	\$1,383	\$1,544	\$1,706	156

RIGHT - Box/file - Pedestal

SHIPS FULLY ASSEMBLED

Locking

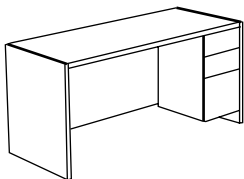

D	W	Recessed Front #	Flush Front #	Recessed to Floor #	Zone 0	Zone 1	Zone 2	WT
36"	72"	2L62-XC	25L62-XC	21L62-XC	\$2,235	\$2,396	\$2,558	390
36"	66"	2L66-XC	25L66-XC	21L66-XC	\$2,208	\$2,370	\$2,532	354
36"	60"	2L60-XC	25L60-XC	21L60-XC	\$2,090	\$2,252	\$2,414	312
30"	72"	2L02-XC	25L02-XC	21L02-XC	\$2,104	\$2,265	\$2,427	342
30"	66"	2L06-XC	25L06-XC	21L06-XC	\$2,064	\$2,227	\$2,388	318
30"	60"	2L00-XC	25L00-XC	21L00-XC	\$1,920	\$2,083	\$2,243	294
24"	72"	2L42-XC	25L42-XC	21L42-XC	\$1,854	\$2,017	\$2,177	249
24"	66"	2L46-XC	25L46-XC	21L46-XC	\$1,802	\$1,964	\$2,126	204
24"	60"	2L40-XC	25L40-XC	21L40-XC	\$1,723	\$1,886	\$2,046	174
24"	48"	2L48-XC	25L48-XC	21L48-XC	\$1,645	\$1,806	\$1,968	156

RIGHT - Box/box/file - Pedestal

SHIPS FULLY ASSEMBLED

Locking

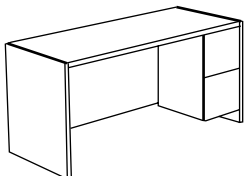

D	W	Recessed Front #	Flush Front #	Recessed to Floor #	Zone 0	Zone 1	Zone 2	WT
36"	72"	2L62-XD	25L62-XD	21L62-XD	\$2,235	\$2,396	\$2,558	390
36"	66"	2L66-XD	25L66-XD	21L66-XD	\$2,208	\$2,370	\$2,532	354
36"	60"	2L60-XD	25L60-XD	21L60-XD	\$2,090	\$2,252	\$2,414	312
30"	72"	2L02-XD	25L02-XD	21L02-XD	\$2,104	\$2,265	\$2,427	342
30"	66"	2L06-XD	25L06-XD	21L06-XD	\$2,064	\$2,227	\$2,388	318
30"	60"	2L00-XD	25L00-XD	21L00-XD	\$1,920	\$2,083	\$2,243	294
24"	72"	2L42-XD	25L42-XD	21L42-XD	\$1,854	\$2,017	\$2,177	249
24"	66"	2L46-XD	25L46-XD	21L46-XD	\$1,802	\$1,964	\$2,126	204
24"	60"	2L40-XD	25L40-XD	21L40-XD	\$1,723	\$1,886	\$2,046	174
24"	48"	2L48-XD	25L48-XD	21L48-XD	\$1,645	\$1,806	\$1,968	156

RIGHT - File/file - Pedestal

SHIPS FULLY ASSEMBLED

Locking

Classic 5



Classic Collection



Edge

SERIES 200 - The Classic Collection Single Pedestal Desk

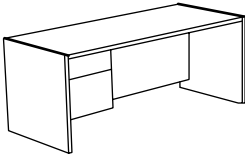

D	W	Recessed Front #	Flush Front #	Recessed to Floor #	Zone 0	Zone 1	Zone 2	WT
36"	72"	2M62-BX	25M62-BX	21M62-BX	\$1,973	\$2,134	\$2,296	390
36"	66"	2M66-BX	25M66-BX	21M66-BX	\$1,946	\$2,108	\$2,270	354
36"	60"	2M60-BX	25M60-BX	21M60-BX	\$1,842	\$2,003	\$2,165	312
30"	72"	2M02-BX	25M02-BX	21M02-BX	\$1,854	\$2,017	\$2,177	342
30"	66"	2M06-BX	25M06-BX	21M06-BX	\$1,828	\$1,990	\$2,152	318
30"	60"	2M00-BX	25M00-BX	21M00-BX	\$1,697	\$1,859	\$2,021	294
24"	72"	2M42-BX	25M42-BX	21M42-BX	\$1,645	\$1,806	\$1,968	249
24"	66"	2M46-BX	25M46-BX	21M46-BX	\$1,592	\$1,755	\$1,915	204
24"	60"	2M40-BX	25M40-BX	21M40-BX	\$1,514	\$1,675	\$1,837	174
24"	48"	2M48-BX	25M48-BX	21M48-BX	\$1,383	\$1,544	\$1,706	156

LEFT - Box/file - Pedestal

Locking

SHIPS FULLY ASSEMBLED

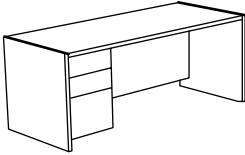

D	W	Recessed Front #	Flush Front #	Recessed to Floor #	Zone 0	Zone 1	Zone 2	WT
36"	72"	2L62-CX	25L62-CX	21L62-CX	\$2,235	\$2,396	\$2,558	390
36"	66"	2L66-CX	25L66-CX	21L66-CX	\$2,208	\$2,370	\$2,532	354
36"	60"	2L60-CX	25L60-CX	21L60-CX	\$2,090	\$2,252	\$2,414	312
30"	72"	2L02-CX	25L02-CX	21L02-CX	\$2,104	\$2,265	\$2,427	342
30"	66"	2L06-CX	25L06-CX	21L06-CX	\$2,064	\$2,227	\$2,388	318
30"	60"	2L00-CX	25L00-CX	21L00-CX	\$1,920	\$2,083	\$2,243	294
24"	72"	2L42-CX	25L42-CX	21L42-CX	\$1,854	\$2,017	\$2,177	249
24"	66"	2L46-CX	25L46-CX	21L46-CX	\$1,802	\$1,964	\$2,126	204
24"	60"	2L40-CX	25L40-CX	21L40-CX	\$1,723	\$1,886	\$2,046	174
24"	48"	2L48-CX	25L48-CX	21L48-CX	\$1,645	\$1,806	\$1,968	156

LEFT - Box/box/file - Pedestal

SHIPS FULLY ASSEMBLED

Locking

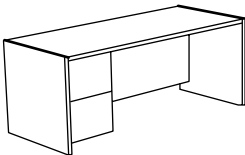

D	W	Recessed Front #	Flush Front #	Recessed to Floor #	Zone 0	Zone 1	Zone 2	WT
36"	72"	2L62-DX	25L62-DX	21L62-DX	\$2,235	\$2,396	\$2,558	390
36"	66"	2L66-DX	25L66-DX	21L66-DX	\$2,208	\$2,370	\$2,532	354
36"	60"	2L60-DX	25L60-DX	21L60-DX	\$2,090	\$2,252	\$2,414	312
30"	72"	2L02-DX	25L02-DX	21L02-DX	\$2,104	\$2,265	\$2,427	342
30"	66"	2L06-DX	25L06-DX	21L06-DX	\$2,064	\$2,227	\$2,388	318
30"	60"	2L00-DX	25L00-DX	21L00-DX	\$1,920	\$2,083	\$2,243	294
24"	72"	2L42-DX	25L42-DX	21L42-DX	\$1,854	\$2,017	\$2,177	249
24"	66"	2L46-DX	25L46-DX	21L46-DX	\$1,802	\$1,964	\$2,126	204
24"	60"	2L40-DX	25L40-DX	21L40-DX	\$1,723	\$1,886	\$2,046	174
24"	48"	2L48-DX	25L48-DX	21L48-DX	\$1,645	\$1,806	\$1,968	156

LEFT - File/file - Pedestal

SHIPS FULLY ASSEMBLED

Locking

Classic 6



Classic Collection

Edge

SERIES 200 - The Classic Collection Executive Returns / LEFT

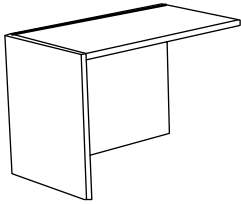

D	W	Model#	Zone 0	Zone 1	Zone 2	WT
20"	54"	2E54-OX	\$1,434	\$1,544	\$1,680	216
20"	48"	2E48-OX	\$1,225	\$1,335	\$1,471	186
20"	42"	2E42-OX	\$1,199	\$1,309	\$1,444	162
20"	36"	2E36-OX	\$1,172	\$1,283	\$1,418	138
24"	54"	24E54-OX	\$1,369	\$1,479	\$1,615	216
24"	48"	24E48-OX	\$1,291	\$1,400	\$1,536	186
24"	42"	24E42-OX	\$1,252	\$1,362	\$1,496	162
24"	36"	24E36-OX	\$1,225	\$1,335	\$1,471	138

LEFT - No Pedestal

SHIPS FULLY ASSEMBLED

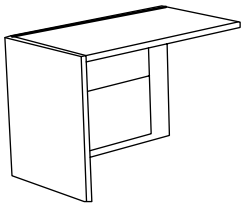

D	W	Model#	Zone 0	Zone 1	Zone 2	WT
20"	54"	2E54-BX	\$1,592	\$1,702	\$1,837	258
20"	48"	2E48-BX	\$1,527	\$1,637	\$1,771	222
20"	42"	2E42-BX	\$1,487	\$1,597	\$1,733	198
20"	36"	2E36-BX	\$1,474	\$1,584	\$1,719	174
24"	54"	24E54-BX	\$1,711	\$1,821	\$1,955	258
24"	48"	24E48-BX	\$1,645	\$1,755	\$1,890	222
24"	42"	24E42-BX	\$1,618	\$1,728	\$1,864	198
24"	36"	24E36-BX	\$1,580	\$1,689	\$1,824	174

LEFT - Box/file - Pedestal

Locking

SHIPS FULLY ASSEMBLED

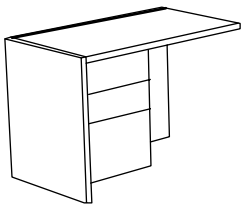

D	W	Model#	Zone 0	Zone 1	Zone 2	WT
20"	54"	2E54-CX	\$1,697	\$1,808	\$1,942	252
20"	48"	2E48-CX	\$1,618	\$1,728	\$1,864	232
20"	42"	2E42-CX	\$1,592	\$1,702	\$1,837	208
20"	36"	2E36-CX	\$1,553	\$1,663	\$1,798	198
24"	54"	24E54-CX	\$1,736	\$1,846	\$2,060	252
24"	48"	24E48-CX	\$1,684	\$1,794	\$1,929	232
24"	42"	24E42-CX	\$1,645	\$1,755	\$1,890	208
24"	36"	24E36-CX	\$1,618	\$1,728	\$1,864	198

LEFT - Box/box/file - Pedestal

Locking

SHIPS FULLY ASSEMBLED

Classic 7



Classic Collection

Edge

SERIES 200 - The Classic Collection Executive Returns / RIGHT

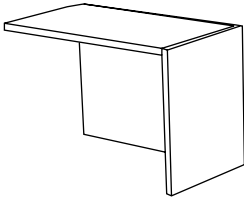

D	W	Model#	Zone 0	Zone 1	Zone 2	WT
20"	54"	2E54-XO	\$1,434	\$1,544	\$1,680	216
20"	48"	2E48-XO	\$1,225	\$1,335	\$1,471	186
20"	42"	2E42-XO	\$1,199	\$1,309	\$1,444	162
20"	36"	2E36-XO	\$1,172	\$1,283	\$1,418	138
24"	54"	24E54-XO	\$1,369	\$1,479	\$1,615	216
24"	48"	24E48-XO	\$1,291	\$1,400	\$1,536	186
24"	42"	24E42-XO	\$1,252	\$1,362	\$1,496	162
24"	36"	24E36-XO	\$1,225	\$1,335	\$1,471	138

RIGHT - No Pedestal
SHIPS FULLY ASSEMBLED

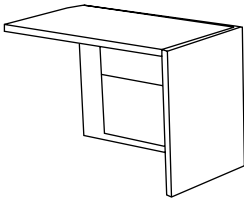

D	W	Model#	Zone 0	Zone 1	Zone 2	WT
20"	54"	2E54-XB	\$1,592	\$1,702	\$1,837	258
20"	48"	2E48-XB	\$1,527	\$1,637	\$1,771	222
20"	42"	2E42-XB	\$1,487	\$1,597	\$1,733	198
20"	36"	2E36-XB	\$1,474	\$1,584	\$1,719	174
24"	54"	24E54-XB	\$1,711	\$1,821	\$1,955	258
24"	48"	24E48-XB	\$1,645	\$1,755	\$1,890	222
24"	42"	24E42-XB	\$1,618	\$1,728	\$1,864	198
24"	36"	24E36-XB	\$1,580	\$1,689	\$1,824	174

RIGHT - Box/file - Pedestal
Locking
SHIPS FULLY ASSEMBLED

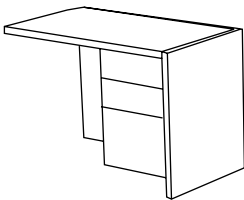

D	W	Model#	Zone 0	Zone 1	Zone 2	WT
20"	54"	2E54-XC	\$1,697	\$1,808	\$1,942	252
20"	48"	2E48-XC	\$1,618	\$1,728	\$1,864	232
20"	42"	2E42-XC	\$1,592	\$1,702	\$1,837	208
20"	36"	2E36-XC	\$1,553	\$1,663	\$1,798	198
24"	54"	24E54-XC	\$1,736	\$1,846	\$2,060	252
24"	48"	24E48-XC	\$1,684	\$1,794	\$1,929	232
24"	42"	24E42-XC	\$1,645	\$1,755	\$1,890	208
24"	36"	24E36-XC	\$1,618	\$1,728	\$1,864	198

RIGHT - Box/box/file - Pedestal
Locking
SHIPS FULLY ASSEMBLED

Classic 8



Classic Collection

Edge

SERIES 200 - The Classic Collection Filler Tops Between Desks & Credenza - Non - Handed

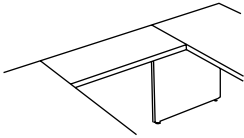

D	W	Model#	Zone 0	Zone 1	Zone 2	WT
20"	48"	2ET08	\$373	\$418	\$474	54
20"	42"	2ET02	\$347	\$392	\$448	46
20"	36"	2ET06	\$308	\$352	\$408	36
24"	48"	2ET48	\$413	\$457	\$514	54
24"	42"	2ET42	\$386	\$431	\$488	46
24"	36"	2ET46	\$360	\$405	\$461	38

29" H WITHOUT back panel
SHIPS KD

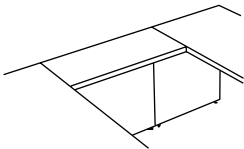

D	W	Model#	Zone 0	Zone 1	Zone 2	WT
20"	48"	2ETF08	\$793	\$889	\$947	54
20"	42"	2ETF02	\$819	\$863	\$920	46
20"	36"	2ETF06	\$793	\$838	\$894	36
24"	48"	2ETF48	\$897	\$942	\$998	54
24"	42"	2ETF42	\$872	\$889	\$976	46
24"	36"	2ETF46	\$859	\$903	\$959	38

29" H WITH back panel
SHIPS KD

SERIES 200 - Corner Units - 42" D x 42"W x 29"H - Use 24"D Return

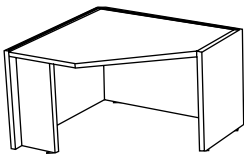

W	Model#	Zone 1	Zone 2	Zone 3	WT
42"	2CT42L9	\$1,252	\$1,296	\$1,353	190

NOTE: Use with LEFT Return
SHIPS FULLY ASSEMBLED

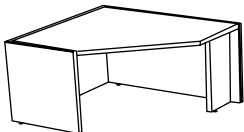

W	Model#	Zone 1	Zone 2	Zone 3	WT
42"	2CT42R9	\$1,252	\$1,296	\$1,353	190

NOTE: Use with RIGHT Return
SHIPS FULLY ASSEMBLED

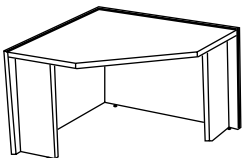

W	Model#	Zone 1	Zone 2	Zone 3	WT
42"	2CT42RL9	\$1,252	\$1,296	\$1,353	190

NOTE: Use with LEFT & RIGHT Return
SHIPS FULLY ASSEMBLED

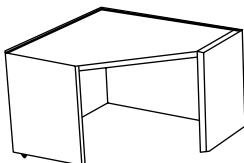

W	Model#	Zone 1	Zone 2	Zone 3	WT
42"	2CT42FS9	\$1,252	\$1,296	\$1,353	190

NOTE: This unit is freestanding
SHIPS FULLY ASSEMBLED

Classic 9



Classic Collection

Edge

SERIES 200 - The Classic Collection Executive Credenzas

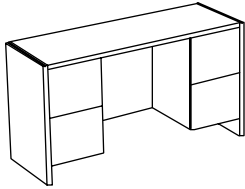

D	W	Recessed Front #	Flush Front #	Zone 0	Zone 1	Zone 2	WT
22"	72"	2L72-DXD	25L72-DXD	\$2,090	\$2,252	\$2,388	270
22"	60"	2L60-DXD	25L60-DXD	\$2,043	\$2,207	\$2,342	259

Left/File/file - Pedestal
Right/File/file - Pedestal

Kneespace
Locking

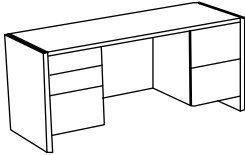

D	W	Recessed Front #	Flush Front #	Zone 0	Zone 1	Zone 2	WT
22"	72"	2L72-CXD	25L72-CXD	\$2,090	\$2,252	\$2,388	270
22"	60"	2L60-CXD	25L60-CXD	\$2,043	\$2,207	\$2,342	259

Locking
LEFT - Box/file/file - Pedestal
RIGHT - File/file - Pedestal

Kneespace
SHIPS FULL ASSEMBLED

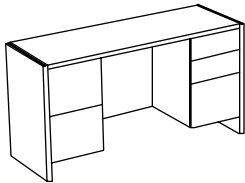

D	W	Recessed Front #	Flush Front #	Zone 0	Zone 1	Zone 2	WT
22"	72"	2L72-DXC	25L72-DXC	\$2,090	\$2,252	\$2,388	270
22"	60"	2L60-DXC	25L60-DXC	\$2,043	\$2,207	\$2,342	259

Locking
RIGHT - Box/file/file - Pedestal
LEFT - File/file - Pedestal

Kneespace
SHIPS FULL ASSEMBLED

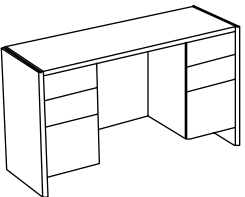

D	W	Recessed Front #	Flush Front #	Zone 0	Zone 1	Zone 2	WT
22"	72"	2L72-CXC	25L72-CXC	\$2,090	\$2,252	\$2,388	270
22"	60"	2L60-CXC	25L60-CXC	\$2,043	\$2,207	\$2,342	259

Locking
RIGHT - Box/file/file - Pedestal
LEFT - Box/file/file - Pedestal

Kneespace
SHIPS FULL ASSEMBLED

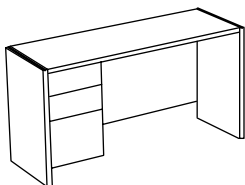

D	W	Recessed Front #	Flush Front #	Zone 0	Zone 1	Zone 2	WT
22"	72"	2L72-CXX	25L72-CXX	\$1,776	\$1,938	\$2,073	170
22"	60"	2L60-CXX	25L60-CXX	\$1,658	\$1,821	\$1,955	159

Locking
LEFT - Box/file/file - Pedestal

Kneespace
SHIPS FULL ASSEMBLED

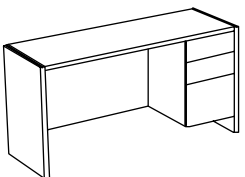

D	W	Recessed Front #	Flush Front #	Zone 0	Zone 1	Zone 2	WT
22"	72"	2L72-XXC	25L72-XXC	\$1,776	\$1,938	\$2,073	170
22"	60"	2L60-XXC	25L60-XXC	\$1,658	\$1,821	\$1,955	159

Locking
RIGHT - Box/file/file - Pedestal

Kneespace
SHIPS FULL ASSEMBLED

Classic 10



Classic Collection



Edge

SERIES 200 - The Classic Collection Executive Credenzas

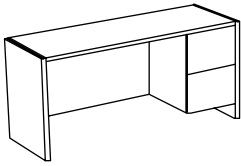

D	W	Recessed Front #	Flush Front #	Zone 0	Zone 1	Zone 2	WT
22"	72"	2L72-XXD	25L72-XXD	\$1,776	\$1,938	\$2,073	170
22"	60"	2L60-XXD	25L60-XXD	\$1,658	\$1,821	\$1,955	159

Locking
RIGHT - File/file - Pedestal
 Kneespace
SHIPS FULL ASSEMBLED

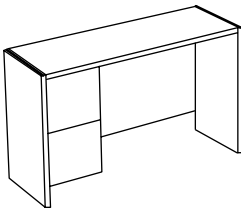

D	W	Recessed Front #	Flush Front #	Zone 0	Zone 1	Zone 2	WT
22"	72"	2L72-DXX	25L72-DXX	\$1,776	\$1,938	\$2,073	170
22"	60"	2L60-DXX	25L60-DXX	\$1,658	\$1,821	\$1,955	159

Locking
LEFT - File/file - Pedestal
 Kneespace
SHIPS FULL ASSEMBLED

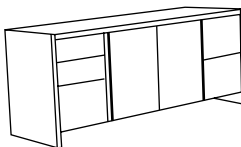

D	W	Recessed Front #	Flush Front #	Zone 0	Zone 1	Zone 2	WT
22"	72"	2L72-CND	25L72-CND	\$3,021	\$3,182	\$3,318	348
22"	60"	2L60-CPD	25L60-CPD	\$2,797	\$2,960	\$3,095	332

LEFT - Box/box/file - Pedestal
RIGHT - File/file - Pedestal
CENTER - Two Doors
SHIPS FULLY ASSEMBLED
 *****2CL - LOCKING_ FOR ENTIRE UNIT*****
ADD \$300 LIST

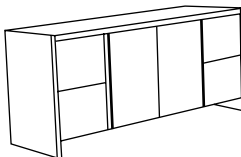

D	W	Recessed Front #	Flush Front #	Zone 0	Zone 1	Zone 2	WT
22"	72"	2L72-DND	25L72-DND	\$3,021	\$3,182	\$3,318	348
22"	60"	2L60-DPD	25L60-DPD	\$2,797	\$2,960	\$3,095	332

LEFT - File/file - Pedestal
RIGHT - File/file - Pedestal
CENTER - Two Doors
SHIPS FULLY ASSEMBLED
 *****2CL - LOCKING_ FOR ENTIRE UNIT*****
ADD \$300 LIST

Classic 11



Classic Collection



Edge

SERIES 200 - The Classic Collection Executive Credenzas

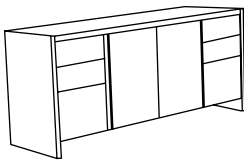

D	W	Recessed Front #	Flush Front #	Zone 0	Zone 1	Zone 2	WT
22"	72"	2L72-CNC	25L72-CNC	\$3,021	\$3,182	\$3,318	348
22"	60"	2L60-CPC	25L60-CPC	\$2,797	\$2,960	\$3,095	332

LEFT - Box/file/file - Pedestal
RIGHT - Box/file/file - Pedestal
CENTER - Two Doors
SHIPS FULLY ASSEMBLED

*****2CL - LOCKING_ FOR ENTIRE UNIT*****
ADD \$300 LIST

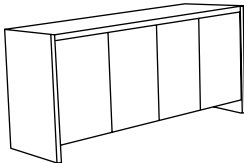

D	W	Recessed Front #	Flush Front #	Zone 0	Zone 1	Zone 2	WT
22"	72"	2L72-NN	25L72-NN	\$2,300	\$2,462	\$2,597	348
22"	60"	2L60-QQ	25L60-QQ	\$2,169	\$2,345	\$2,479	332

Four Doors
SHIPS FULLY ASSEMBLED

*****2CL - LOCKING_ FOR ENTIRE UNIT*****
ADD \$300 LIST

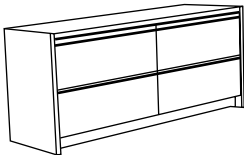

D	W	Recessed Front #	Flush Front #	Zone 0	Zone 1	Zone 2	WT
22"	72"	2L72-GG	25L72-GG	\$3,138	\$3,301	\$3,436	330

Four Drawer Lateral
SHIPS FULLY ASSEMBLED

*****2CL - LOCKING_ FOR ENTIRE UNIT*****
ADD \$300 LIST

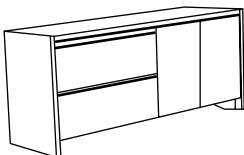

D	W	Recessed Front #	Flush Front #	Zone 0	Zone 1	Zone 2	WT
22"	60"	2L60-GP	25L60-GP	\$2,679	\$2,842	\$2,978	282

LEFT - Two Drawer Lateral File
RIGHT - Two Doors
SHIPS FULLY ASSEMBLED

*****2CL - LOCKING_ FOR ENTIRE UNIT*****
ADD \$300 LIST

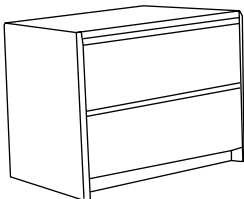

D	W	Recessed Front #	Flush Front #	Zone 0	Zone 1	Zone 2	WT
22"	37.5"	2L36-GL	25L36-GL	\$1,631	\$1,794	\$1,929	210

NOTE: Locks are standard
SHIPS FULLY ASSEMBLED

Classic 12



Classic Collection

Edge

SERIES 200 - The Classic Collection Table Desks

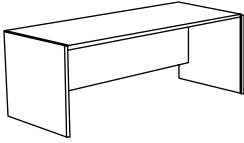

D	W	Recessed Front #	Flush Front #	Recessed to Floor#	Zone 0	Zone 1	Zone 2	WT
30"	72"	2T20	25T20	21T20	\$1,448	\$1,610	\$1,746	318
30"	66"	2T60	25T60	21T60	\$1,383	\$1,544	\$1,680	288
30"	60"	2T00	25T00	21T60	\$1,317	\$1,479	\$1,615	258
30"	48"	2T80	25T80	21T80	\$1,147	\$1,309	\$1,444	216
30"	42"	2T02	25T02	21T02	\$990	\$1,151	\$1,287	210
24"	72"	2T24	25T24	21T24	\$1,186	\$1,348	\$1,484	214
24"	66"	2T64	25T64	21T64	\$1,134	\$1,296	\$1,431	195
24"	60"	2T04	25T04	21T04	\$1,107	\$1,269	\$1,405	192
24"	48"	2T84	25T84	21T84	\$950	\$1,113	\$1,247	168
24"	42"	2T42	25T42	21T42	\$897	\$1,060	\$1,195	155
24"	36"	2T46	25T46	21T46	\$885	\$1,047	\$1,182	162

All Table Desk are 29"H

SHIPS FULLY ASSEMBLED

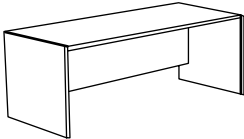

D	W	Recessed to Floor#	Zone 0	Zone 1	Zone 2	WT
24"	72"	2T6472	\$1,186	\$1,348	\$1,484	204
24"	60"	2T6460	\$1,081	\$1,244	\$1,378	186
24"	48"	2T6448	\$963	\$1,126	\$1,260	168
24"	36"	2T6436	\$858	\$1,020	\$1,156	142
24"	30"	2T6430	\$832	\$995	\$1,129	132
24"	24"	2T6424	\$766	\$929	\$1,064	108
30"	72"	2T6072	\$1,448	\$1,610	\$1,746	214
30"	60"	2T6060	\$1,291	\$1,453	\$1,588	192
30"	48"	2T6048	\$1,120	\$1,282	\$1,418	168

All Table Desk are 26"H

SHIPS FULLY ASSEMBLED

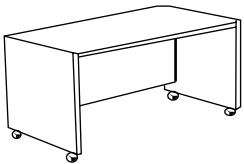

D	W	Recessed to Floor#	Zone 0	Zone 1	Zone 2	WT
24"	36"	2TC436	\$950	\$1,113	\$1,195	142
24"	60"	2TC430	\$910	\$1,073	\$1,209	132
24"	48"	2TC424	\$897	\$1,060	\$1,195	108

All table are 29"H with casters

SHIPS FULLY ASSEMBLED

SERIES 200 - The Classic Collection Overstorage Components / Task Lights

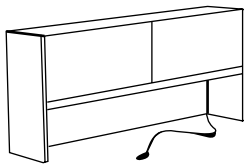

H	W	Model#	Zone 0	Zone 1	Zone 2	WT
36"	78"	2F678	\$2,654	\$2,816	\$2,951	222
36"	72"	2F672	\$2,470	\$2,633	\$2,767	216
36"	66"	2F666	\$2,431	\$2,593	\$2,728	202
36"	60"	2F660	\$2,379	\$2,541	\$2,676	182
36"	48"	2F648 (one door)	\$2,064	\$2,227	\$2,361	166
36"	36"	2F636 (one door)	\$1,998	\$2,161	\$2,296	149

Flipper Door - 15"D

NOTE: Task Light included all units

10' cord standard

We recommend a cable cut-out on base unit

SHIPS FULLY ASSEMBLED

SECTION VIEW

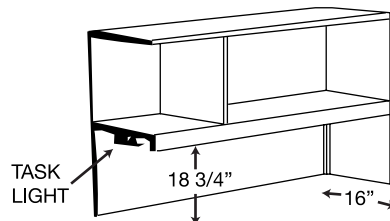

Classic 13



Classic Collection

Edge

SERIES 200 - The Classic Collection Overstorage Components / Task Lights

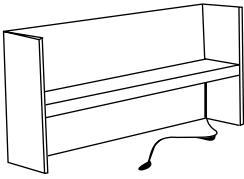

H	W	Model#	Zone 0	Zone 1	Zone 2	WT
36"	78"	2S678	\$1,959	\$2,121	\$2,257	192
36"	72"	2S672	\$1,907	\$2,069	\$2,204	186
36"	66"	2S666	\$1,867	\$2,030	\$2,165	176
36"	60"	2S660	\$1,802	\$1,964	\$2,099	168
36"	48"	2S648	\$1,580	\$1,741	\$1,877	144
36"	36"	2F636	\$1,500	\$1,663	\$1,798	118

Open Shelf - 15"D

SHIPS FULLY ASSEMBLED

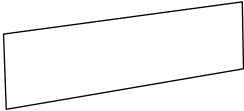

H	W	Model#	Zone 0	Zone 1	Zone 2	WT
18"	78"	2P678	\$413	\$483	\$553	19
18"	72"	2P672	\$400	\$470	\$539	18
18"	66"	2P666	\$386	\$457	\$527	17
18"	60"	2P660	\$360	\$431	\$501	16
18"	48"	2P648	\$335	\$405	\$474	13
18"	36"	2P636	\$255	\$326	\$395	10

Tackboard Panels

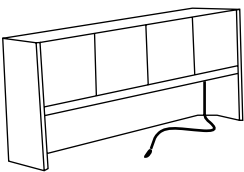

H	W	Model#	Zone 0	Zone 1	Zone 2	WT
42"	72"	2D22-CB	\$3,060	\$3,222	\$3,357	302
42"	60"	2D02-CB	\$2,797	\$2,960	\$3,095	254

Hinged Door 15" D

SHIPS FULLY ASSEMBLED

NOTE: Hinged door overstorage clearance is 21"

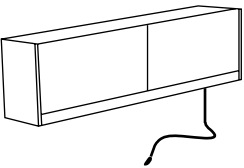

H	W	Model#	Zone 0	Zone 1	Zone 2	WT
17"	72"	2FH72	\$2,051	\$2,214	\$2,348	160
17"	66"	2FH66	\$1,985	\$2,148	\$2,283	153
17"	60"	2FH60	\$1,920	\$2,080	\$2,217	145
17"	54"	2FH54	\$1,842	\$2,003	\$2,139	138
17"	48"	2FH48 (one door)	\$1,514	\$1,675	\$1,811	128
17"	42"	2FH42 (one door)	\$1,448	\$1,610	\$1,746	121
17"	36"	2FH36 (one door)	\$1,369	\$1,532	\$1,667	114
17"	30"	2FH30 (one door)	\$1,303	\$1,466	\$1,602	107

Wall Hung Flipper Door 15"D

SHIPS FULLY ASSEMBLED



H	W	Model#	Zone 0	Zone 1	Zone 2	WT
17"	72"	2SH72	\$1,527	\$1,689	\$1,824	112
17"	66"	2SH66	\$1,500	\$1,663	\$1,806	109
17"	60"	2SH60	\$1,448	\$1,610	\$1,781	105
17"	54"	2SH54	\$1,383	\$1,544	\$1,680	102
17"	48"	2SH48	\$1,291	\$1,453	\$1,588	96
17"	42"	2SH42	\$1,172	\$1,335	\$1,471	93
17"	36"	2SH36	\$990	\$1,151	\$1,287	90
17"	30"	2SH30	\$845	\$1,007	\$1,143	87

NOTE: To Add Top - \$279 additional

SHIPS FULLY ASSEMBLED

WALL HUNG OPEN SHELF 15" D

Classic 14



Classic Collection

Edge

SERIES 200 - The Classic Collection Run-Off Tables

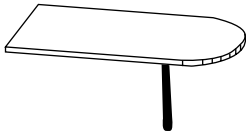

Dimensions	Model#	Zone 0	Zone 1	Zone 2	WT
30" x 66"	RT3066	\$1,041	\$1,151	\$1,260	114
30" x 60"	RT3060	\$976	\$1,100	\$1,209	96
30" x 54"	RT3054	\$950	\$1,060	\$1,169	77

SHIPS KD

Freestanding Run-Off Tables

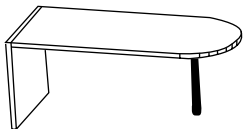

Dimensions	Model#	Zone 0	Zone 1	Zone 2	WT
30" x 60"	2RT3060	\$1,265	\$1,388	\$1,496	128
30" x 66"	2RT3066	\$1,356	\$1,479	\$1,615	146
30" x 72"	2RT3072	\$1,434	\$1,558	\$1,680	164

SHIPS KD

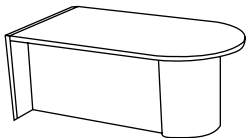

Dimensions	Model#	Zone 0	Zone 1	Zone 2	WT
30" x 60"	2MRT3060	\$2,457	\$2,593	\$2,754	204
30" x 66"	2MRT3066	\$2,614	\$2,751	\$2,912	229
30" x 72"	2MRT3072	\$2,759	\$2,895	\$3,029	252

Half Cylinder w/ Modesty Panel
SHIPS FULLY ASSEMBLED

The Classic Collection "P" Tables

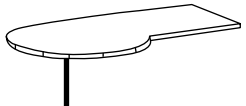

Dimensions	Model#	Zone 0	Zone 1	Zone 2	WT
30" x 66" x 42"	PT3066	\$1,330	\$1,571	\$1,588	129
30" x 72" x 42"	PT3072	\$1,592	\$1,728	\$1,850	138
36" x 66" x 48"	PT3666	\$1,749	\$1,886	\$2,008	142
36" x 72" x 48"	PT3672	\$1,867	\$2,003	\$2,126	151

NOTE: Mounting holes are predrilled
SHIPS KD

SERIES 200 - The Classic Collection "P" Tables - Freestanding "P" Tables

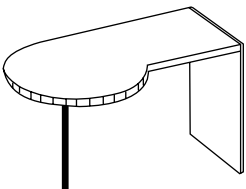

Dimensions	Model#	Zone 0	Zone 1	Zone 2	WT
30" x 66" x 42"	2PT3066	\$1,527	\$1,650	\$1,784	160
30" x 72" x 42"	2PT3072	\$1,723	\$1,846	\$1,981	169
36" x 66" x 48"	2PT3666	\$1,828	\$1,963	\$2,099	173
36" x 72" x 48"	2PT3672	\$1,973	\$2,095	\$2,230	182

NOTE: Mounting holes are predrilled
SHIPS KD

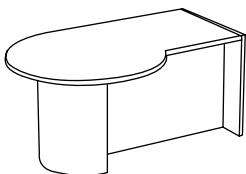

Dimensions	Model#	Zone 0	Zone 1	Zone 2	WT
30" x 66" x 42"	2MPT3066	\$2,732	\$2,855	\$2,978	229
30" x 72" x 42"	2MPT3072	\$2,876	\$3,000	\$3,122	252
36" x 66" x 48"	2MPT3666	\$3,021	\$3,144	\$3,265	254
36" x 72" x 48"	2MPT3672	\$3,165	\$3,288	\$3,409	277

NOTE: Mounting holes are predrilled
Half cylinder w/Modesty Panel
SHIPS FULLY ASSEMBLED

Classic 15



Classic Collection



SERIES 5000 - Component Work Areas

Tops 1 1/8" particle board, 45 lb. density, high pressure laminate on top and edges plus backing on bottom
Intermediate sizes: Specify length using next higher size price.

Order by: 5WT Width X Length

Shipping Weight = 5lb X Sq Ft.

The Component Series allows you to shape your own work space.

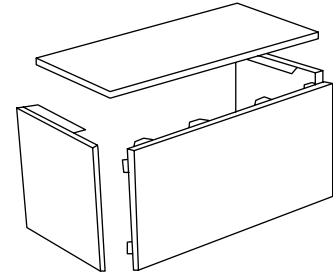
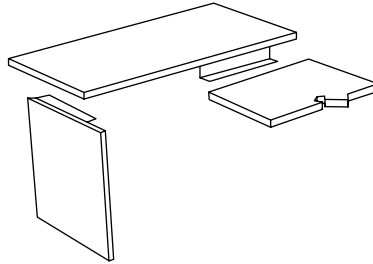
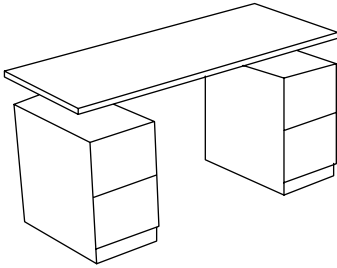

Component Work Tops

H	W	Model#	Zone 0	Zone 1	Zone 2
24"	42"	5WT2442	\$269	\$339	\$395
24"	48"	5WT2448	\$308	\$378	\$434
24"	54"	5WT2454	\$360	\$431	\$488
24"	60"	5WT2460	\$373	\$445	\$501
24"	66"	5WT2466	\$483	\$491	\$539
24"	72"	5WT2472	\$452	\$523	\$579
24"	84"	5WT2484	\$543	\$614	\$670
24"	96"	5WT2496	\$622	\$693	\$750
24"	108"	5WT24108	\$714	\$785	\$841
24"	120"	5WT24120	\$806	\$876	\$932
30"	30"	5WT3030	\$190	\$261	\$317
30"	36"	5WT3036	\$255	\$326	\$383
30"	42"	5WT3042	\$308	\$379	\$435
30"	48"	5WT3048	\$360	\$431	\$488
30"	54"	5WT3054	\$413	\$483	\$539
30"	60"	5WT3060	\$426	\$496	\$553
30"	66"	5WT3066	\$479	\$549	\$605
30"	72"	5WT3072	\$517	\$589	\$645
30"	84"	5WT3084	\$610	\$680	\$736
30"	96"	5WT3096	\$714	\$785	\$841
30"	108"	5WT30108	\$806	\$876	\$932
30"	120"	5WT30120	\$897	\$969	\$1,025
36"	24"	5WT3624	\$216	\$287	\$343
36"	30"	5WT3630	\$255	\$326	\$383
36"	36"	5WT3636	\$308	\$379	\$435
36"	42"	5WT3642	\$360	\$431	\$488
36"	48"	5WT3648	\$426	\$496	\$553
36"	54"	5WT3654	\$491	\$562	\$619
36"	60"	5WT3660	\$517	\$589	\$645
36"	66"	5WT3666	\$583	\$654	\$710
36"	72"	5WT3672	\$635	\$707	\$763
36"	84"	5WT3684	\$753	\$824	\$881
36"	96"	5WT3696	\$872	\$942	\$998
36"	108"	5WT36108	\$990	\$1,060	\$1,116
36"	120"	5WT36120	\$1,107	\$1,178	\$1,234

Classic 16



SERIES 5000 - Component Modesty Panels

Modesty Panels are 1 1/4" thick particle board, 45lb. Density, high pressure laminate on both sides.

To determine price on intermediate sizes, use price shown for the next larger length.

Modesty panels are supplied with angle brackets for mounting to legs and tops.

Modesty panels is designed to go underneath top and between legs. Three edges of panel are unfinished.

Order by: 5MP Width X Length

Shipping Weight = 5lb X Sq Ft.

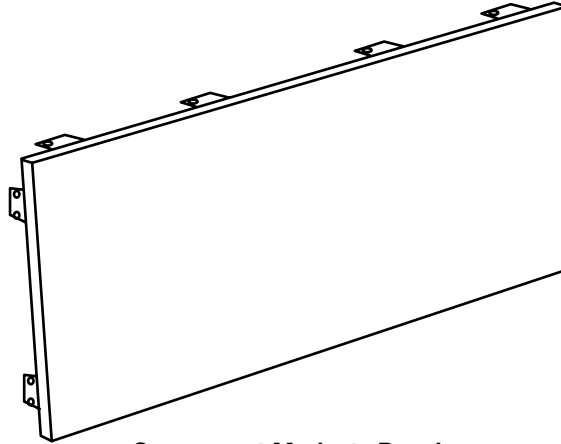

Component Modesty Panels

W	L	Model#	Zone 0	Zone 1	Zone 2
24"	25"	5MP2425	\$124	\$195	\$252
30"	25"	5MP3025	\$177	\$248	\$304
36"	25"	5MP3625	\$229	\$300	\$357
42"	25"	5MP4225	\$282	\$352	\$408
48"	25"	5MP4825	\$321	\$392	\$448
54"	25"	5MP5425	\$373	\$445	\$501
60"	25"	5MP6025	\$400	\$470	\$527
66"	25"	5MP6625	\$439	\$510	\$566
72"	25"	5MP7225	\$491	\$562	\$619
84"	25"	5MP8425	\$570	\$641	\$697
96"	25"	5MP9625	\$806	\$876	\$932
108"	25"	5MP10825	\$819	\$889	\$947
120"	25"	5MP12025	\$845	\$916	\$972
24"	28"	5MP2428	\$177	\$248	\$304
30"	28"	5MP3028	\$204	\$274	\$330
36"	28"	5MP3628	\$269	\$339	\$395
42"	28"	5MP4228	\$321	\$392	\$448
48"	28"	5MP4828	\$386	\$457	\$514
54"	28"	5MP5428	\$439	\$510	\$566
60"	28"	5MP6028	\$452	\$523	\$579
66"	28"	5MP6628	\$466	\$536	\$592
72"	28"	5MP7228	\$517	\$589	\$645
84"	28"	5MP8428	\$622	\$693	\$750
96"	28"	5MP9628	\$779	\$785	\$815
108"	28"	5MP10828	\$598	\$889	\$947
120"	28"	5MP12028	\$924	\$995	\$1,051

NOTE: Must supply drawing for size adjustment on modesty



Classic Collection



Edge

SERIES 5000 - Component Work Area

Panel Supports

1 1/8" particle board, 45lb. density, high pressure laminate on all exposed surfaces.

Supplied with mounting hardware and leveling glides

Order by: 5PS Width X Length

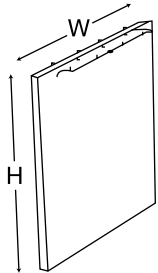

W	H	Model #	Zone 0	Zone 1	Zone 2	WT
22"	25"	5PS2225	\$190	\$234	\$277	19
24"	25"	5PS2425	\$248	\$295	\$383	26
30"	25"	5PS3025	\$229	\$274	\$317	36
36"	25"	5PS3625	\$295	\$339	\$383	46
12"	25"	5PS1225	\$177	\$221	\$264	11
15"	25"	5PS1525	\$190	\$234	\$277	14
22"	28"	5PS2228	\$204	\$248	\$291	19
24"	28"	5PS2428	\$308	\$261	\$395	26
30"	28"	5PS3028	\$242	\$287	\$330	36
36"	28"	5PS3628	\$308	\$352	\$395	46
12"	28"	5PS1228	\$190	\$234	\$277	11
15"	28"	5PS1528	\$204	\$248	\$291	14

Corner Top

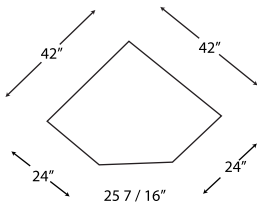

Model #	Zone 0	Zone 1	Zone 2	WT
5CT	\$498	\$549	\$592	65

Corner Leg Support

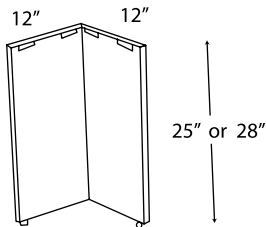

H	Model #	Zone 0	Zone 1	Zone 2	WT
25"	5CLS25	\$452	\$496	\$539	30
28"	5CLS28	\$466	\$510	\$553	30

NOTE: Corner Leg support is shipped in two pieces & is assembled with mod-eza clips.

Freestanding Corner

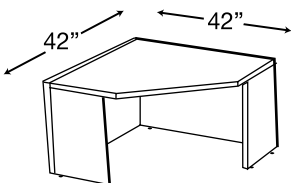

H	Model #	Zone 0	Zone 1	Zone 2	WT
26"	5CTBP26	\$1,252	\$1,296	\$1,340	190
29"	5CTBP29	\$1,252	\$1,296	\$1,340	190

SHIPS FULLY ASSEMBLED

Classic 18



SERIES 5000 - Component Work Area Mounting Hardware

Flat Plates



Model#	Length (in.)	Unit Price
5MH-2	13	\$30
5MH-5	8	\$25

"L" Angles

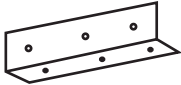

Model#	Length (in.)	Unit Price
5MH-3	20	\$40

Spacers

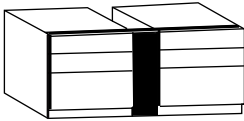

Dimensions	Model#	Unit Price
1 1/4 x 24"H x 5"D	SPA-24	\$100
1 1/4"x27 3/4Hx5"D	SPA-27	\$100

Spacers available when ganging
900 Series Freestanding Pedestals



Classic Collection



Edge

SERIES 1100 - Freestanding Bookcase

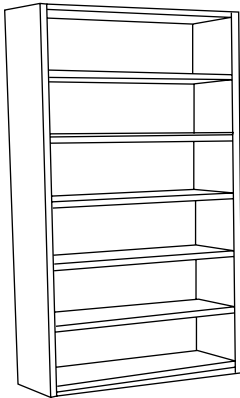

Shelves	H	D	30"W Model	Zone 0	Zone 1	Zone 2	WT
7	84"	12"	11B084-F	\$1,985	\$2,030	\$2,073	215
6	78"	12"	11B078-F	\$1,867	\$1,912	\$1,955	201
5	72"	12"	11B072-F	\$1,749	\$1,794	\$1,837	187
4	60"	12"	11B060-F	\$1,580	\$1,624	\$1,667	166
3	48"	12"	11B048-F	\$1,291	\$1,335	\$1,378	145
2	41"	12"	11B041-F	\$1,159	\$1,204	\$1,247	131
2	36"	12"	11B036-F	\$1,055	\$1,100	\$1,143	127
1	28"	12"	11B028-F	\$965	\$1,020	\$1,064	117
7	84"	18"	11B8084-F	\$2,457	\$2,501	\$2,545	294
6	78"	18"	11B8078-F	\$2,286	\$2,331	\$2,374	274
5	72"	18"	11B8072-F	\$2,129	\$2,174	\$2,217	255
4	60"	18"	11B8060-F	\$1,880	\$1,925	\$1,968	225
3	48"	18"	11B8048-F	\$1,553	\$1,597	\$1,640	196
2	41"	18"	11B8041-F	\$1,382	\$1,427	\$1,471	175
2	36"	18"	11B8036-F	\$1,225	\$1,269	\$1,313	147
1	28"	18"	11B8028-F	\$1,134	\$1,178	\$1,221	144

30" Wide Bookcases

**NOTE: ALL UNITS ARE FINISHED ON ALL SIDES
SHIPS FULLY ASSEMBLED**

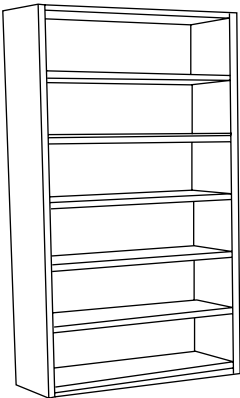

Shelves	H	D	36"W Model	Zone 0	Zone 1	Zone 2	WT
7	84"	12"	11B84-F	\$2,182	\$2,227	\$2,270	215
6	78"	12"	11B78-F	\$2,051	\$2,095	\$2,139	201
5	72"	12"	11B72-F	\$1,907	\$1,952	\$1,995	187
4	60"	12"	11B60-F	\$1,711	\$1,755	\$1,802	166
3	48"	12"	11B48-F	\$1,396	\$1,440	\$1,484	145
2	41"	12"	11B41-F	\$1,252	\$1,296	\$1,340	131
2	36"	12"	11B36-F	\$1,265	\$1,309	\$1,353	127
1	28"	12"	11B28-F	\$1,041	\$1,086	\$1,129	117
7	84"	18"	11B8684-F	\$2,706	\$2,751	\$2,794	294
6	78"	18"	11B8678-F	\$2,523	\$2,567	\$2,610	274
5	72"	18"	11B8672-F	\$2,352	\$2,383	\$2,401	255
4	60"	18"	11B8660-F	\$2,064	\$2,108	\$2,152	225
3	48"	18"	11B8648-F	\$1,697	\$1,741	\$1,784	196
2	41"	18"	11B8641-F	\$1,500	\$1,544	\$1,588	175
2	36"	18"	11B8636-F	\$1,317	\$1,362	\$1,405	147
1	28"	18"	11B8628-F	\$1,212	\$1,257	\$1,300	144

36" Wide Bookcases

**NOTE: ALL UNITS ARE FINISHED ON ALL SIDES
SHIPS FULLY ASSEMBLED**

Classic 20



Classic Collection



Edge

SERIES 1100 - Storage Cabinets and Wardrobes

Finished Outside Back	Shelves	H	D	36"W Model	Zone 0	Zone 1	Zone 2	WT
	5	72"	19"	11C72-F	\$2,483	\$2,593	\$2,702	344
	4	60"	19"	11C60-F	\$2,051	\$2,161	\$2,270	268
	3	48"	19"	11C48-F	\$1,749	\$1,938	\$1,968	250
	2	41"	19"	11C41-F	\$1,736	\$1,846	\$1,955	248
	2	36"	19"	11C36-F	\$1,514	\$1,624	\$1,733	170
	1	28"	19"	11C28-F	\$1,382	\$1,493	\$1,602	130

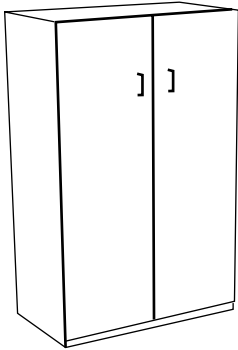

Storage Cabinets - with adjustable shelves

NOTE: All units are finished on all sides; includes adjustable levelers.

Inside measurements of storage cabinets are standard:

34 3/8"W x 17 3/4"D x 25"H

34 3/8"W x 17 3/4"D x 33"H

34 3/8"W x 17 3/4"D x 38"H

34 3/8"W x 17 3/4"D x 45"H

34 3/8"W x 17 3/4"D x 57"H

SHIPS FULLY ASSEMBLED

LOCK ON STORAGE CABINET \$140 LIST

W	D	H	Model#	Zone 0	Zone 1	Zone 2	WT
36"	24"	72"	11CW-72	\$3,034	\$3,144	\$3,253	322

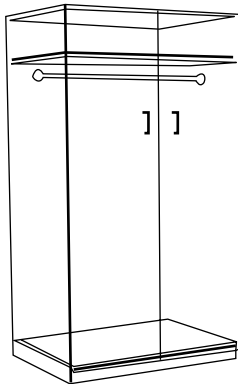

Two Doors w/Hat Shelf & Coat Pole

SHIPS FULLY ASSEMBLED

LOCK ON STORAGE CABINET \$140 LIST

W	D	H	Model#	Zone 0	Zone 1	Zone 2	WT
36"	24"	72"	11CWC-72	\$3,361	\$3,471	\$3,580	322

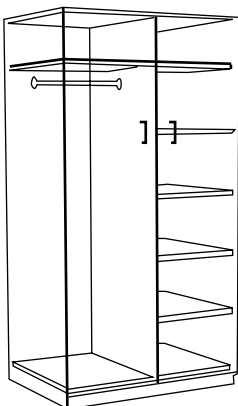

Two Doors w/Hat Shelf & Coat Pole on one side and Shelves on other side.

SHIPS FULLY ASSEMBLED

LOCK ON STORAGE CABINET \$140 LIST

Classic 21



Classic Collection



Edge

SERIES 1100 - Bookcases/Storage and Storage/Lateral Combinations

Bookcase/Storage	W	D	H	Model#	Zone 0	Zone 1	Zone 2	WT
	36"	22"	76"	9K22LLBC	\$3,178	\$3,288	\$3,700	350

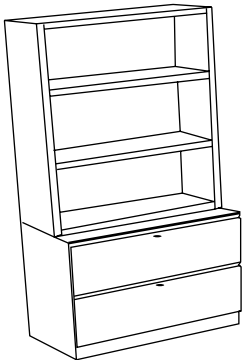

NOTE: Locks are standard
SHIPS FULLY ASSEMBLED

W	D	H	Model#	Zone 0	Zone 1	Zone 2	WT
36"	22"	76"	9K22DDSBC	\$2,902	\$3,013	\$2,991	322

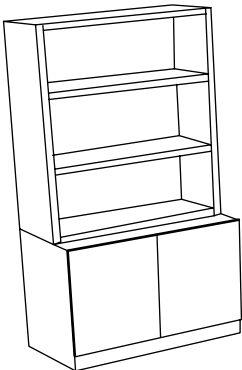

SHIPS FULLY ASSEMBLED
LOCK ON STORAGE CABINET \$140 LIST

W	D	H	Model#	Zone 0	Zone 1	Zone 2	WT
36"	22"	72"	9K22LLSC	\$3,440	\$3,550	\$3,659	385

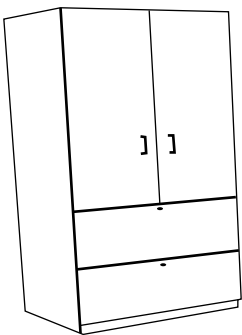

SHIPS FULLY ASSEMBLED
LOCK ON STORAGE CABINET \$140 LIST

Classic 22



Classic Collection



Edge

SERIES 900 - Free Standing Pedestals

Base Pedestal

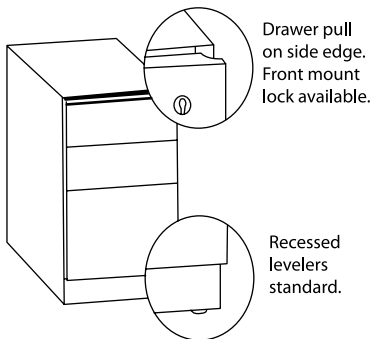

Mobile Pedestal

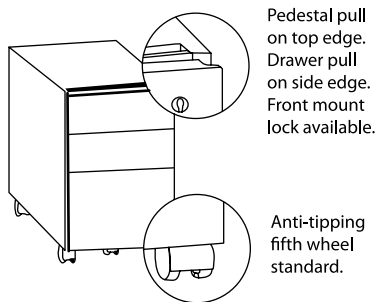

D	W	28"H / Model#	Zone 0	Zone 1	Zone 2	WT
18"	16"	9K18-BBF	\$859	\$916	\$972	96
22"	16"	9K22-BBF	\$963	\$1,020	\$1,078	108
28"	16"	9K28-BBF	\$1,055	\$1,113	\$1,169	126

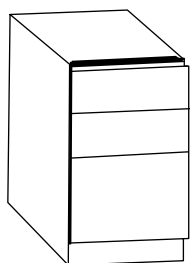

Base Pedestal

Box/box/file -BBF

SHIPS FULLY ASSEMBLED

NOTE: FOR LOCK ADD /L TO MODEL # AND ADD \$100 TO LIST.

D	W	27"H / Model#	Zone 0	Zone 1	Zone 2	WT
18"	16"	9C18-BBF	\$859	\$916	\$972	96
22"	16"	9C22-BBF	\$963	\$1,020	\$1,078	108
28"	16"	9C28-BBF	\$1,055	\$1,113	\$1,169	126

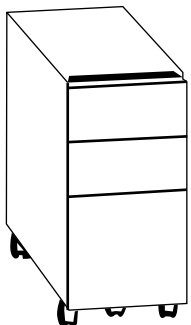

Mobile Pedestal

Box/box/file -BBF

SHIPS FULLY ASSEMBLED

NOTE: FOR LOCK ADD /L TO MODEL # AND ADD \$100 TO LIST.

D	W	28"H / Model#	Zone 0	Zone 1	Zone 2	WT
18"	16"	9K18-FF	\$859	\$916	\$972	96
22"	16"	9K22-FF	\$963	\$1,020	\$1,078	108
28"	16"	9K28-FF	\$1,055	\$1,113	\$1,169	126

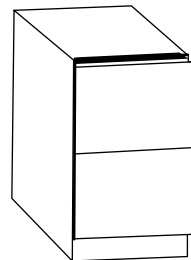

Base Pedestal

File/file -FF

SHIPS FULLY ASSEMBLED

NOTE: FOR LOCK ADD /L TO MODEL # AND ADD \$100 TO LIST.

D	W	27"H / Model#	Zone 0	Zone 1	Zone 2	WT
18"	16"	9C18-FF	\$859	\$916	\$972	96
22"	16"	9C22-FF	\$963	\$1,020	\$1,078	108
28"	16"	9C28-FF	\$1,055	\$1,113	\$1,169	126

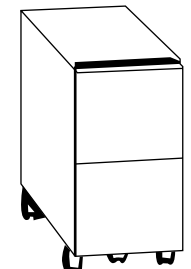

Mobile Pedestal

File/file -FF

SHIPS FULLY ASSEMBLED

NOTE: FOR LOCK ADD /L TO MODEL # AND ADD \$100 TO LIST.

Classic 23



Classic Collection



Edge

SERIES 900 - Free Standing Pedestals

Base Pedestal

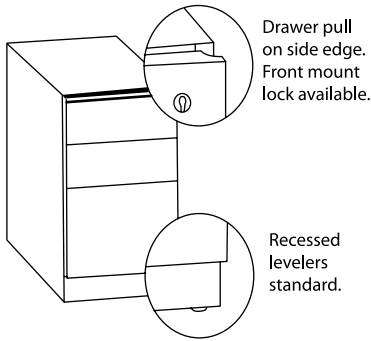

Mobile Pedestal

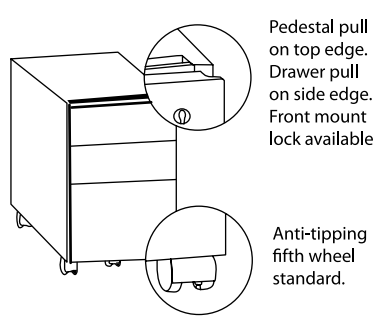

D	W	28"H / Model#	Zone 0	Zone 1	Zone 2	WT
18"	16"	9K18-BBBB	\$859	\$916	\$972	96
22"	16"	9K22-BBBB	\$963	\$1,020	\$1,078	108
28"	16"	9K28-BBBB	\$1,055	\$1,113	\$1,169	126

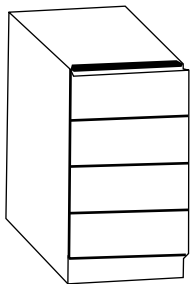

Base Pedestal

Box/box/box/box-BBBB

SHIPS FULLY ASSEMBLED

NOTE: FOR LOCK ADD /L TO MODEL # AND ADD \$100 TO LIST.

D	W	27"H / Model#	Zone 0	Zone 1	Zone 2	WT
18"	16"	9C18-BBBB	\$859	\$916	\$972	96
22"	16"	9C22-BBBB	\$963	\$1,020	\$1,078	108
28"	16"	9C28-BBBB	\$1,055	\$1,113	\$1,169	126

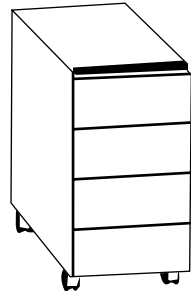

Mobile Pedestal

Box/box/box/box-BBBB

SHIPS FULLY ASSEMBLED

NOTE: FOR LOCK ADD /L TO MODEL # AND ADD \$100 TO LIST.

D	W	25"H / Model#	Zone 0	Zone 1	Zone 2	WT
18"	16"	9K18-TBF	\$859	\$916	\$972	96

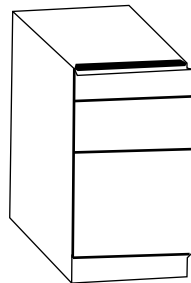

Base Pedestal

Tray/Box/File - T/B/F

Note: TBF is 25"H and 24"H caster

Locking-N/A

SHIPS FULLY ASSEMBLED

D	W	24"H / Model#	Zone 0	Zone 1	Zone 2	WT
18"	16"	9C18-TBF	\$859	\$916	\$972	96

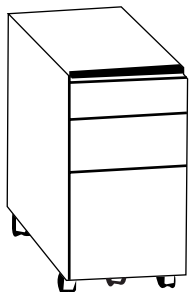

Mobile Pedestal

Tray/Box/File - T/B/F

Locking - N/A

SHIPS FULLY ASSEMBLED

Classic 24



SERIES 900 - Free Standing Pedestals

Base Pedestal

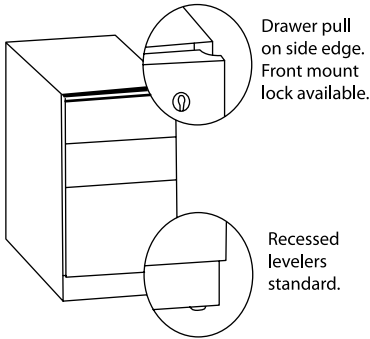

Drawer pull on side edge. Front mount lock available.

Recessed levelers standard.

Mobile Pedestal

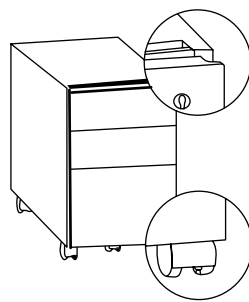

Pedestal pull on top edge. Drawer pull on side edge. Front mount lock available

Anti-tipping fifth wheel standard.

D	W	28"H / Model#	Zone 0	Zone 1	Zone 2	WT
18"	18"	9K18-DS	\$832	\$889	\$947	84
18"	22"	9K22-DS	\$872	\$931	\$985	96

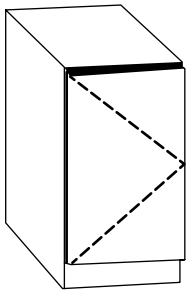

Base Pedestal

Door Storage / 1 shelf

Note: Specify Hinge **LEFT** or **RIGHT**

Extra Shelf add \$66 to List

FOR LOCK ADD /L TO MODEL # AND ADD \$100 TO LIST.

SHIPS FULLY ASSEMBLED

D	W	27"H / Model#	Zone 0	Zone 1	Zone 2	WT
18"	18"	9C18-DS	\$832	\$889	\$947	84
18"	22"	9C22-DS	\$872	\$931	\$985	96

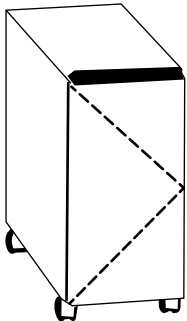

Mobile Pedestal

Door Storage / 1 shelf

Note: Specify Hinge **LEFT** or **RIGHT**

Extra Shelf add \$66 to List

FOR LOCK ADD /L TO MODEL # AND ADD \$100 TO LIST.

SHIPS FULLY ASSEMBLED

D	W	28"H / Model#	Zone 0	Zone 1	Zone 2	WT
18"	18"	9K18-DDS	\$1,229	\$1,286	\$1,344	120
18"	22"	9K22-DDS	\$1,303	\$1,362	\$1,418	138

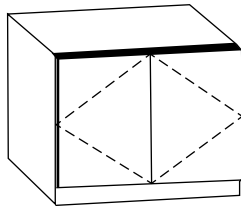

Base Pedestal

Note: "Extra Shelf" add \$110 to List

FOR LOCK ADD /L TO MODEL # AND ADD \$100 TO LIST.

SHIPS FULLY ASSEMBLED

D	W	27"H / Model#	Zone 0	Zone 1	Zone 2	WT
18"	18"	9C18-DDS	\$1,229	\$1,286	\$1,344	120
18"	22"	9C22-DDS	\$1,303	\$1,362	\$1,418	138

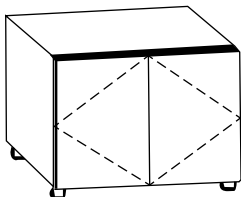

Base Pedestal

Note: "Extra Shelf" add \$110 to List

FOR LOCK ADD /L TO MODEL # AND ADD \$100 TO LIST.

SHIPS FULLY ASSEMBLED



Classic Collection



Edge

SERIES 900 - Lateral File Units

2 Drawer Lateral File	D	W	H	Model#	Zone 0	Zone 1	Zone 2	WT
	22"	36"	28"	9K22L/L	\$1,645	\$1,702	\$1,759	210
	22"	30"	28"	9K02L/L	\$1,645	\$1,702	\$1,759	190

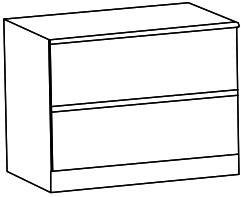

NOTE: All Units come standard with locks.
 All units accommodate legal and letter size pendaflex files.
SHIPS FULLY ASSEMBLED

3 Drawer Lateral File	D	W	H	Model#	Zone 0	Zone 1	Zone 2	WT
	22"	36"	40"	9K23L/L	\$2,300	\$2,358	\$2,414	270
	22"	30"	40"	9K03L/L	\$2,300	\$2,358	\$2,414	240

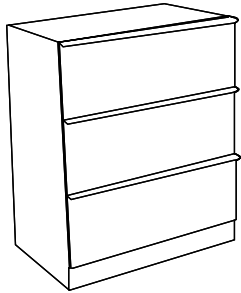

NOTE: All Units come standard with locks.
 All units accommodate legal and letter size pendaflex files.
SHIPS FULLY ASSEMBLED

4 Drawer Lateral File	D	W	H	Model#	Zone 0	Zone 1	Zone 2	WT
	22"	36"	52"	9K24L/L	\$2,772	\$2,829	\$2,885	360
	22"	30"	52"	9K04L/L	\$2,772	\$2,829	\$2,885	320

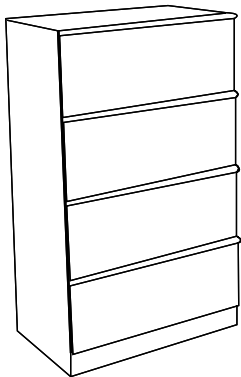

NOTE: All Units come standard with locks.
 All units accommodate legal and letter size pendaflex files.
SHIPS FULLY ASSEMBLED

Classic 26



Curved Desk Specifications

Base Model

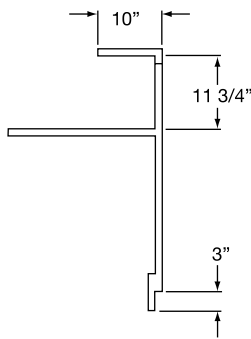

- Tops** 1 1/8" particle board covered on all exposed surfaces with high pressure laminate. Inside radius: 24". Outside radius: 48".
- End Panels** 2 3/8" particle board covered all exposed surfaces with high pressure laminate.
- Curved Front Panels** Curved framed construction. Covered on all exposed exterior and interior Surfaces with high pressure plastic laminate. Curved wall under worksurface is finished in only black.
- Recessed Base** 3" black, standard - chrome or brass finish optional
- Leveling Glides** Supplied on all units. Glides are adjustable.

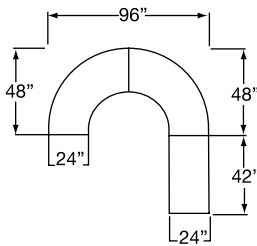

- Accent Strips** 1 / 8" accent strip in black, standard - chrome or brass finish optional
- Finishes** Check Finish Section of L.U.I.+PLUS catalog for availability and up-charges.
- Shipping** All units shipped disassembled in sections.
- Modifications** Other sizes and configurations are available. Consult factory
- Note:** Momentum Recessed Base - 3" oak, walnut, mahogany, black, maple or cherry. Momentum Accent Strips - 1/4" accent strip in oak, walnut, mahogany, black, maple or cherry - optional

Flush Model

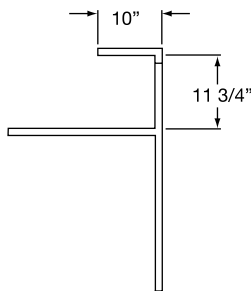

- Tops** 1 1/8" particle board covered on all exposed surfaces with high pressure laminate. Inside radius: 24". Outside radius: 48".
- End Panels** 1 1/4" particle board covered all exposed surfaces with high pressure laminate.
- Curved Front Panels** Curved framed construction. Covered on all exposed exterior and interior Surfaces with high pressure plastic laminate. Curved wall under worksurface is finished in only black.
- Recessed Base** Not available
- Leveling Glides** Supplied on all units. Glides are adjustable.

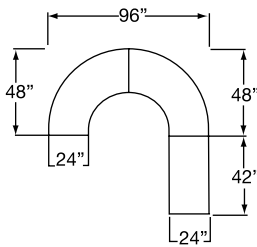

- Accent Strips** 1 / 8" accent strip in black, standard - chrome or brass finish optional
- Finishes** Check Finish Section of L.U.I.+PLUS catalog for availability and up-charges.
- Shipping** All units shipped disassembled in sections.
- Modifications** Other sizes and configurations are available. Consult factory
- Note:** Momentum Recessed Base - 3" oak, walnut, mahogany, black, maple or cherry. Momentum Accent Strips - 1/4" accent strip in oak, walnut, mahogany, black, maple or cherry - optional



Classic Collection

Edge

Series 100 Base Curved Desks

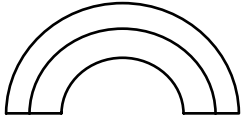

30" High

Model#	Zone 0	Zone 1	Zone 2	WT
1BC-B	\$8,210	\$8,962	\$9,477	600

42" High w/ Transaction Ledge

Model#	Zone 0	Zone 1	Zone 2	WT
1BC-B/L	\$11,983	\$12,735	\$13,250	600

Half Circle - Ships in TWO SECTIONS

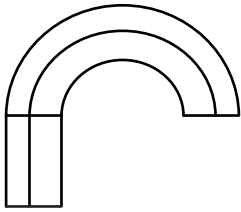

30" High

Model#	Zone 0	Zone 1	Zone 2	WT
1BRC-B	\$10,044	\$10,797	\$11,312	816

42" High w/ Transaction Ledge

Model#	Zone 0	Zone 1	Zone 2	WT
1BRC-B/L	\$14,631	\$15,383	\$15,898	816

Half Circle with LEFT return - Ships in THREE SECTIONS

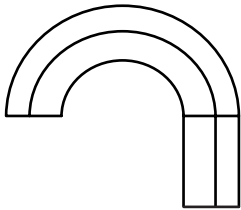

30" High

Model#	Zone 0	Zone 1	Zone 2	WT
1BCR-B	\$10,044	\$10,797	\$11,312	816

42" High w/ Transaction Ledge

Model#	Zone 0	Zone 1	Zone 2	WT
1BCR-B/L	\$14,631	\$15,383	\$15,898	816

Half Circle with RIGHT return - Ships in THREE SECTIONS

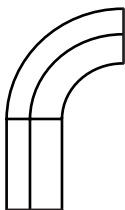

30" High

Model#	Zone 0	Zone 1	Zone 2	WT
1BRQ-B	\$6,585	\$7,075	\$7,590	540

42" High w/ Transaction Ledge

Model#	Zone 0	Zone 1	Zone 2	WT
1BRQ-B/L	\$9,324	\$10,076	\$10,591	540

Quarter Circle with LEFT return - Ships in TWO SECTIONS

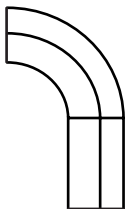

30" High

Model#	Zone 0	Zone 1	Zone 2	WT
1BQR-B	\$6,585	\$7,075	\$7,590	540

42" High w/ Transaction Ledge

Model#	Zone 0	Zone 1	Zone 2	WT
1BQR-B/L	\$9,324	\$10,076	\$10,591	540

Quarter Circle with RIGHT return - Ships in TWO SECTIONS

NOTE: Optional Accessories Refer to back of Pricelist

Classic 28



Series 100 Base Curved Desks

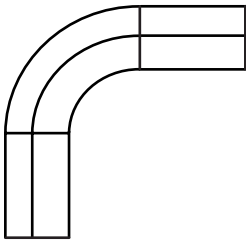

30" High Model#	Zone 0	Zone 1	Zone 2	WT
1BRQR-B	\$8,052	\$8,804	\$9,319	780

42" High w/ Transaction Ledge Model#	Zone 0	Zone 1	Zone 2	WT
1BRQR-B/L	\$11,787	\$12,539	\$13,054	540

Quarter Circle w/ **LEFT & RIGHT** Return
Ships in THREE SECTIONS

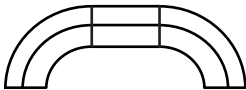

30" High Model#	Zone 0	Zone 1	Zone 2	WT
1BQRQ-B	\$10,332	\$11,085	\$11,599	816

42" High w/ Transaction Ledge Model#	Zone 0	Zone 1	Zone 2	WT
1BQRQ-B/L	\$14,840	\$1,553	\$16,107	816

Two Quarter Circle w/ non - handed return
Ships in THREE SECTIONS

NOTES: Returns are standard at 29" executive height and 42" wide.

Gloss finish is available at 25% upcharge

The above pricing is for black reveal & base only.

When specifying chrome or brass. **(-C or -BR) ADD \$350 to LIST PRICE)**

Other configurations - Consult factory Customer Service for pricing and specifications on special configurations of Curved Desk Components.

NOTE: Optional Accessories Refer to back of Pricelist

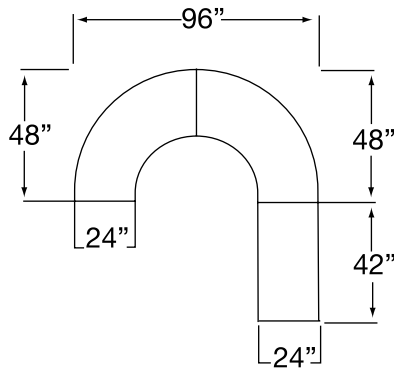



Series 100 Flush Curved Desks (No Base)

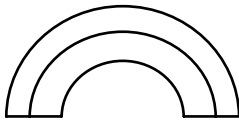

30" High Model#	Zone 0	Zone 1	Zone 2	WT
1FC-B	\$5,942	\$6,695	\$7,210	525

42" High w/ Transaction Ledge Model#	Zone 0	Zone 1	Zone 2	WT
1FC-B/L	\$8,773	\$9,525	\$10,040	525

Half Circle - Ships in TWO SECTIONS

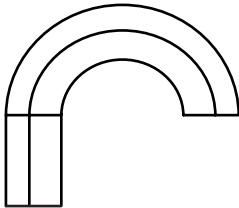

30" High Model#	Zone 0	Zone 1	Zone 2	WT
1FRC-B	\$7,515	\$8,267	\$8,782	690

42" High w/ Transaction Ledge Model#	Zone 0	Zone 1	Zone 2	WT
1FRC-B/L	\$11,026	\$11,780	\$12,294	690

Half Circle with **LEFT** return - Ships in THREE SECTIONS

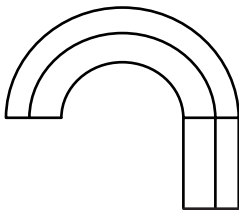

30" High Model#	Zone 0	Zone 1	Zone 2	WT
1FCR-B	\$7,515	\$8,267	\$8,782	690

42" High w/ Transaction Ledge Model#	Zone 0	Zone 1	Zone 2	WT
1FCR-B/L	\$11,026	\$11,780	\$12,294	690

Half Circle with **RIGHT** return - Ships in THREE SECTIONS

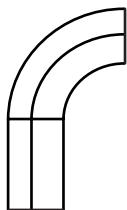

30" High Model#	Zone 0	Zone 1	Zone 2	WT
1FRQ-B	\$4,410	\$5,162	\$5,677	468

42" High w/ Transaction Ledge Model#	Zone 0	Zone 1	Zone 2	WT
1FRQ-B/L	\$6,598	\$7,350	\$7,865	468

Quarter Circle with **LEFT** return - Ships in TWO SECTIONS

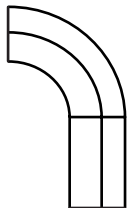

30" High Model#	Zone 0	Zone 1	Zone 2	WT
1FQR-B	\$4,410	\$5,162	\$5,677	468

42" High w/ Transaction Ledge Model#	Zone 0	Zone 1	Zone 2	WT
1FQR-B/L	\$6,598	\$7,350	\$7,865	468

Quarter Circle with **RIGHT** return - Ships in TWO SECTIONS

NOTE: Optional Accessories Refer to back of Pricelist

Classic 30



Series 100 Flush Curved Desks (No Base)

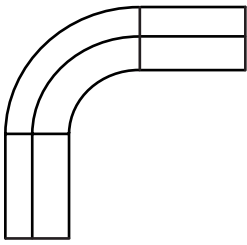

30" High

Model#	Zone 0	Zone 1	Zone 2	WT
1FRQR-B	\$5,693	\$6,446	\$6,960	624

42" High w/ Transaction Ledge

Model#	Zone 0	Zone 1	Zone 2	WT
1FRQR-B/L	\$8,432	\$9,185	\$9,699	624

Quarter Circle w/ **LEFT & RIGHT** Return
Ships in THREE SECTIONS

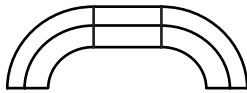

30" High

Model#	Zone 0	Zone 1	Zone 2	WT
1FQRQ-B	\$7,738	\$8,490	\$9,005	690

42" High w/ Transaction Ledge

Model#	Zone 0	Zone 1	Zone 2	WT
1FQRQ-B/L	\$11,211	\$11,962	\$12,478	690

Two Quarter Circle w/ non - handed return
Ships in THREE SECTIONS

NOTES: Returns are standard at 29" executive height and 42" wide.

Gloss finish is available at 25% upcharge

The above pricing is for black reveal & base only.

When specifying chrome or brass. **(-C or -BR) ADD \$350 to LIST PRICE)**

Other configurations - Consult factory Customer Service for pricing and specifications on special configurations of Curved Desk Components.

NOTE: Optional Accessories Refer to back of Pricelist

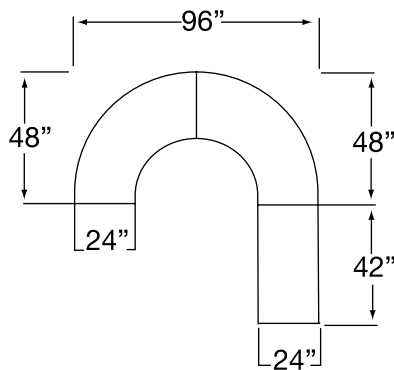

Classic 31



Momentum Solid Wood Edge Base Curved Desks

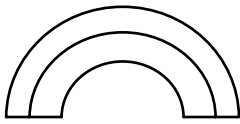

30" High				
Model#	Zone 0	Zone 1	Zone 2	WT
WBC	\$11,342	\$12,093	\$12,608	735

42" High w/ Transaction Ledge				
Model#	Zone 0	Zone 1	Zone 2	WT
WBC/L	\$16,413	\$17,165	\$17,680	735

Half Circle - Ships in TWO SECTIONS

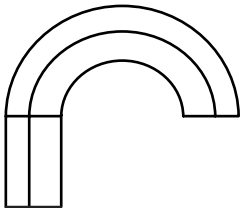

30" High				
Model#	Zone 0	Zone 1	Zone 2	WT
WBRC	\$14,185	\$14,937	\$15,452	1,020

42" High w/ Transaction Ledge				
Model#	Zone 0	Zone 1	Zone 2	WT
WBRC/L	\$20,357	\$21,109	\$21,624	1,020

Half Circle with **LEFT** return - Ships in THREE SECTIONS

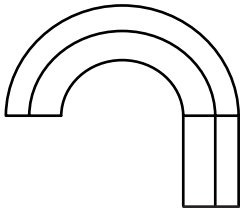

30" High				
Model#	Zone 0	Zone 1	Zone 2	WT
WBCR	\$14,185	\$14,937	\$15,452	1,020

42" High w/ Transaction Ledge				
Model#	Zone 0	Zone 1	Zone 2	WT
WBCR/L	\$20,357	\$21,109	\$21,624	1,020

Half Circle with **RIGHT** return - Ships in THREE SECTIONS

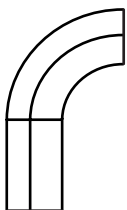

30" High				
Model#	Zone 0	Zone 1	Zone 2	WT
WBRQ	\$9,166	\$9,918	\$10,433	675

42" High w/ Transaction Ledge				
Model#	Zone 0	Zone 1	Zone 2	WT
WBRQ/L	\$13,202	\$13,955	\$14,469	675

Quarter Circle with **LEFT** return - Ships in TWO SECTIONS

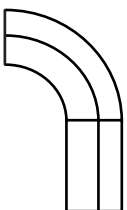

30" High				
Model#	Zone 0	Zone 1	Zone 2	WT
WBQR	\$9,166	\$9,918	\$10,433	675

42" High w/ Transaction Ledge				
Model#	Zone 0	Zone 1	Zone 2	WT
WBQR/L	\$13,202	\$13,955	\$14,469	675

Quarter Circle with **RIGHT** return - Ships in TWO SECTIONS

NOTE: Optional Accessories Refer to back of Pricelist

Classic 32



Momentum Solid Wood Edge Base Curved Desks

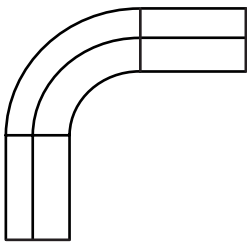

30" High Model#	Zone 0	Zone 1	Zone 2	WT
WBRQR	\$11,486	\$12,238	\$12,753	975

42" High w/ Transaction Ledge Model#	Zone 0	Zone 1	Zone 2	WT
WBRQR/L	\$16,518	\$17,269	\$17,785	975

Quarter Circle w/ **LEFT & RIGHT** Return
Ships in THREE SECTIONS

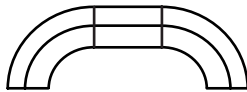

30" High Model#	Zone 0	Zone 1	Zone 2	WT
WBQRQ	\$14,552	\$15,304	\$15,820	1,020

42" High w/ Transaction Ledge Model#	Zone 0	Zone 1	Zone 2	WT
WBQRQ/L	\$20,632	\$21,384	\$21,899	1,020

Two Quarter Circle w/ non - handed return
Ships in THREE SECTIONS

NOTES: Returns are standard at 29" executive height and 42" wide.

Gloss finish is available at 25% upcharge

Other configurations - Consult factory Customer Service for pricing and specifications on special configurations of Curved Desk Components.

NOTE: Optional Accessories Refer to back of Pricelist

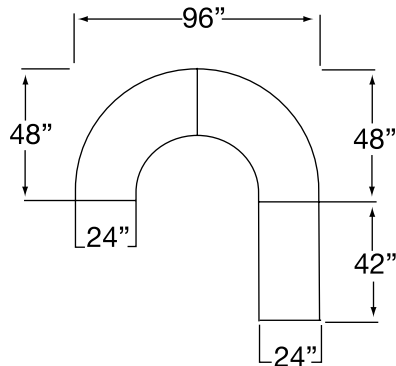



Momentum Solid Wood Edge Flush Curved Desks (No Base)

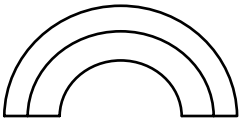

30" High Model#	Zone 0	Zone 1	Zone 2	WT
WFC	\$8,263	\$9,014	\$9,530	625

42" High w/ Transaction Ledge Model#	Zone 0	Zone 1	Zone 2	WT
WFC/L	\$12,088	\$12,841	\$13,356	735

Half Circle - Ships in TWO SECTIONS

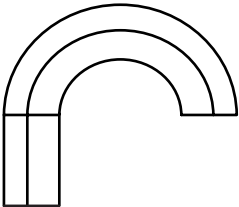

30" High Model#	Zone 0	Zone 1	Zone 2	WT
WFRC	\$10,765	\$11,517	\$12,032	863

42" High w/ Transaction Ledge Model#	Zone 0	Zone 1	Zone 2	WT
WFRC/L	\$15,483	\$16,235	\$16,750	863

Half Circle with LEFT return - Ships in THREE SECTIONS

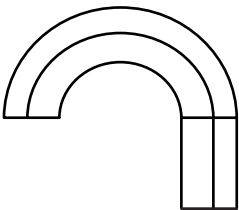

30" High Model#	Zone 0	Zone 1	Zone 2	WT
WFCR	\$10,765	\$11,517	\$12,032	863

42" High w/ Transaction Ledge Model#	Zone 0	Zone 1	Zone 2	WT
WFCR/L	\$15,483	\$16,235	\$16,750	863

Half Circle with RIGHT return - Ships in THREE SECTIONS

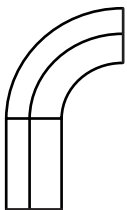

30" High Model#	Zone 0	Zone 1	Zone 2	WT
WFRQ	\$6,572	\$7,324	\$7,839	585

42" High w/ Transaction Ledge Model#	Zone 0	Zone 1	Zone 2	WT
WFRQ/L	\$9,520	\$10,273	\$10,787	585

Quarter Circle with LEFT return - Ships in TWO SECTIONS

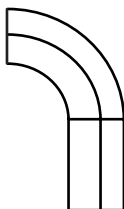

30" High Model#	Zone 0	Zone 1	Zone 2	WT
WFQR	\$6,572	\$7,324	\$7,839	585

42" High w/ Transaction Ledge Model#	Zone 0	Zone 1	Zone 2	WT
WFQR/L	\$9,520	\$10,273	\$10,787	585

Quarter Circle with RIGHT return - Ships in TWO SECTIONS

NOTE: Optional Accessories Refer to back of Pricelist

Classic 34



Momentum Solid Wood Edge Flush Curved Desks (No Base)

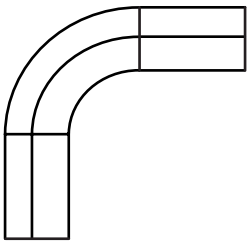

30" High

Model#	Zone 0	Zone 1	Zone 2	WT
WFRQR	\$8,301	\$9,053	\$9,568	780

42" High w/ Transaction Ledge

Model#	Zone 0	Zone 1	Zone 2	WT
WFRQR/L	\$11,983	\$12,735	\$13,250	975

Quarter Circle w/ LEFT & RIGHT Return
Ships in THREE SECTIONS

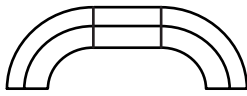

30" High

Model#	Zone 0	Zone 1	Zone 2	WT
WFQRQ	\$11,066	\$11,818	\$12,333	863

42" High w/ Transaction Ledge

Model#	Zone 0	Zone 1	Zone 2	WT
WFQRQ/L	\$15,732	\$16,483	\$16,999	863

Two Quarter Circle w/ non - handed return
Ships in THREE SECTIONS

NOTES: Returns are standard at 29" executive height and 42" wide.

Gloss finish is available at 25% upcharge

Other configurations - Consult factory Customer Service for pricing and specifications on special configurations of Curved Desk Components.

NOTE: Optional Accessories Refer to back of Pricelist

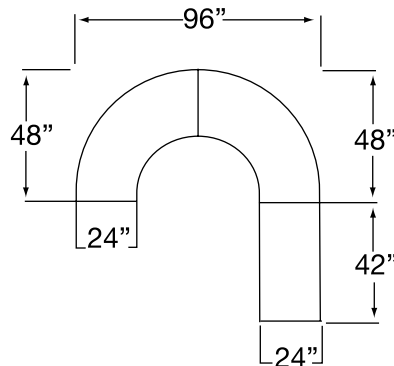



Reception Desk Specifications - Series 110

- Tops & End Panels** 1 1/8" particle board covered on all surfaces with high pressure laminate

- Front Panel** 3/4" particle board covered on all exposed surfaces with high pressure laminate

- Drawers** All wood construction. All exposed surfaces covered with black vinyl.

- File Drawers** Mounted on full extension slides. Accommodates letter or legal size filing.

- Box Drawers** Mounted on full extension slides

- Leveling Glides** Supplied on all units. Glides are adjustable.

- Keying** Standard production is to random key all units

- Keying Alike** Units are needed keyed alike should be specified on order / Purchase Order# (No upcharge)

- Master Keying** Is available on any number of units up to 50 different keys with 1 master key. Master keying should be specified, UPCHARGE \$60 (Master Keys are not shipped with furniture, but sent to ordering dealer or designated agent).

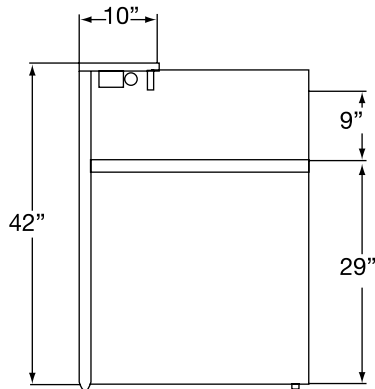



Classic Collection



Edge

Reception Desk Specifications - Series 110

42" High w/ Ledge

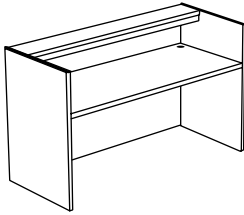

D	W	Model #	Zone 0	Zone 1	Zone 2	WT
30"	84"	14R04	\$2,548	\$2,776	\$2,938	375
30"	72"	14R02	\$2,379	\$2,607	\$2,767	360
30"	66"	14R06	\$2,300	\$2,527	\$2,689	348
30"	60"	14R00	\$2,383	\$2,383	\$2,545	276

Desk 42"H

SHIPS FULLY ASSEMBLED

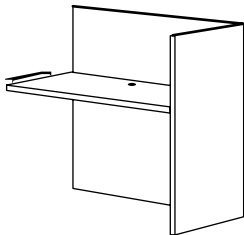

D	W	Model #	Zone 0	Zone 1	Zone 2	WT
20"	54"	14R540	\$1,815	\$2,003	\$2,126	300
20"	48"	14R480	\$1,631	\$1,821	\$1,942	255
20"	42"	14R420	\$1,605	\$1,768	\$1,890	240
20"	36"	14R360	\$1,580	\$1,741	\$1,864	225
24"	54"	14R544	\$1,854	\$2,043	\$2,165	315
24"	48"	14R484	\$1,671	\$1,859	\$1,981	263
24"	42"	14R424	\$1,618	\$1,808	\$1,929	248
24"	36"	14R364	\$1,580	\$1,768	\$1,890	233

RIGHT Returns 42" with Worksurface at 29"H

SHIPS FULLY ASSEMBLED

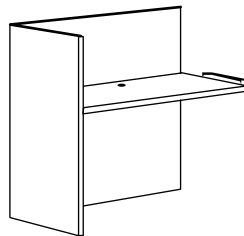

D	W	Model #	Zone 0	Zone 1	Zone 2	WT
20"	54"	14L540	\$1,815	\$2,003	\$2,126	300
20"	48"	14L480	\$1,631	\$1,821	\$1,942	255
20"	42"	14L420	\$1,605	\$1,768	\$1,890	240
20"	36"	14L360	\$1,580	\$1,741	\$1,864	225
24"	54"	14L544	\$1,854	\$2,043	\$2,165	315
24"	48"	14L484	\$1,671	\$1,859	\$1,981	263
24"	42"	14L424	\$1,618	\$1,808	\$1,929	248
24"	36"	14L364	\$1,580	\$1,768	\$1,890	233

LEFT Returns 42" with Worksurface at 29"H

SHIPS FULLY ASSEMBLED

NOTE: Task Light standard with desks

All desks come standard with cable -cut out, with cover on right and left corners.

All returns come standard with cable -cut out with cover, in center back.

If using **LEFT** and **RIGHT** returns to form U-shaped unit, use 20" returns with 72" and 84" desks only to allow adequate kneespace.

Classic 37



Series 800 Panel End Parsons Table (Indicate desired height after model number)

Solid Colors
Seamless Construction

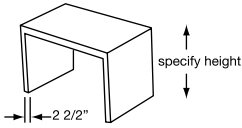

D	W	Panel End #	Zone 0	Zone 1	Zone 2	WT
12"	48"	8EO-4812	\$714	\$811	\$972	70
12"	60"	8EO-6012	\$819	\$916	\$1,078	75
12"	72"	8EO-7212	\$1,003	\$1,100	\$1,260	80
12"	84"	8EO-8412	\$1,186	\$1,282	\$1,444	85
18"	48"	8EO-4818	\$1,041	\$1,138	\$1,300	84
18"	60"	8EO-6018	\$1,278	\$1,375	\$1,536	90
18"	72"	8EO-7218	\$1,565	\$1,663	\$1,824	96
18"	84"	8EO-8418	\$1,802	\$1,899	\$2,060	102
24"	24"	8EO-2424	\$714	\$812	\$973	80
24"	36"	8EO-3624	\$990	\$1,086	\$1,247	88
24"	48"	8EO-4824	\$1,356	\$1,453	\$1,615	96
24"	60"	8EO-6024	\$1,711	\$1,806	\$1,968	115
24"	84"	8EO-8424	\$2,457	\$2,554	\$2,716	136
30"	30"	8EO-3030	\$1,186	\$1,282	\$1,444	105
30"	48"	8EO-4830	\$2,366	\$2,462	\$2,623	120
30"	60"	8EO-6030	\$2,548	\$2,645	\$2,807	150
30"	72"	8EO-7230	\$2,810	\$2,907	\$3,069	160
36"	36"	8EO-3636	\$1,540	\$1,637	\$1,798	132
36"	48"	8EO-4836	\$2,444	\$2,541	\$2,702	144
36"	60"	8EO-6036	\$2,641	\$2,738	\$2,898	180
36"	72"	8EO-7236	\$3,165	\$3,262	\$3,422	192
48"	48"	8EO-4848	\$2,810	\$2,909	\$3,069	192

Series 800 4-Leg Parsons Table (Indicate desired height after model number)

Solid Colors
Seamless Construction

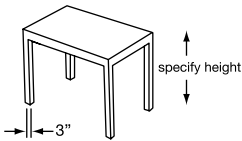

D	W	Parson #	Zone 0	Zone 1	Zone 2	WT
12"	48"	8PO-4812	\$714	\$811	\$972	40
12"	60"	8PO-6012	\$819	\$916	\$1,078	45
12"	72"	8PO-7212	\$1,003	\$1,100	\$1,260	50
12"	84"	8PO-8412	\$1,186	\$1,282	\$1,444	55
18"	48"	8PO-4818	\$1,041	\$1,138	\$1,300	50
18"	60"	8PO-6018	\$1,278	\$1,375	\$1,536	60
18"	72"	8PO-7218	\$1,565	\$1,663	\$1,824	65
18"	84"	8PO-8418	\$1,802	\$1,899	\$2,060	72
24"	24"	8PO-2424	\$714	\$812	\$973	40
24"	36"	8PO-3624	\$990	\$1,086	\$1,247	50
24"	48"	8PO-4824	\$1,356	\$1,453	\$1,615	60
24"	60"	8PO-6024	\$1,711	\$1,806	\$1,968	70
24"	84"	8PO-8424	\$2,457	\$2,554	\$2,716	90
30"	30"	8PO-3030	\$1,186	\$1,282	\$1,444	51
30"	48"	8PO-4830	\$2,366	\$2,462	\$2,623	70
30"	60"	8PO-6030	\$2,548	\$2,645	\$2,807	82
30"	72"	8PO-7230	\$2,810	\$2,907	\$3,069	95
36"	36"	8PO-3636	\$1,540	\$1,637	\$1,798	65
36"	48"	8PO-4836	\$2,444	\$2,541	\$2,702	80
36"	60"	8PO-6036	\$2,641	\$2,738	\$2,898	95
36"	72"	8PO-7236	\$3,165	\$3,262	\$3,422	110
48"	48"	8PO-4848	\$2,810	\$2,909	\$3,069	100

NOTE: Specify required height("H) when ordering. Prices reflect up to 30" height.

31"H to 36"H add 12% to List Price

37"H to 42"H add 20% to List Price

Casters on tables smaller than 18"D x 60"W - **ADD \$290 to LIST**

Intermediate sizes available. Consult factory

Center drawers available. Consult factory.

SHIPS FULLY ASSEMBLED

Classic 38



Classic Collection

Edge

Series 800 Panel End Parsons Table (Indicate desired height after model number)

Woodgrain
Mitered Corner
Construction

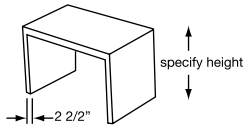

D	W	Panel End #	Zone 0	Zone 1	Zone 2	WT
12"	48"	8ES-4812	\$504	\$601	\$763	70
12"	60"	8ES-6012	\$570	\$667	\$828	75
12"	72"	8ES-7212	\$701	\$798	\$959	80
12"	84"	8ES-8412	\$832	\$929	\$1,090	85
18"	48"	8ES-4818	\$741	\$838	\$998	84
18"	60"	8ES-6018	\$753	\$851	\$1,012	90
18"	72"	8ES-7218	\$1,094	\$1,191	\$1,353	96
18"	84"	8ES-8418	\$1,303	\$1,400	\$1,562	102
24"	24"	8ES-2424	\$504	\$601	\$763	80
24"	36"	8ES-3624	\$701	\$798	\$959	88
24"	48"	8ES-4824	\$976	\$1,073	\$1,234	96
24"	60"	8ES-6024	\$1,225	\$1,322	\$1,484	115
24"	84"	8ES-8424	\$1,762	\$1,859	\$2,021	136
30"	30"	8ES-3030	\$819	\$916	\$1,078	105
30"	48"	8ES-4830	\$1,252	\$1,348	\$1,509	120
30"	60"	8ES-6030	\$1,608	\$1,728	\$1,890	150
30"	72"	8ES-7230	\$2,077	\$2,174	\$2,348	160
36"	36"	8ES-3636	\$1,094	\$1,191	\$1,353	132
36"	48"	8ES-4836	\$1,487	\$1,584	\$1,746	144
36"	60"	8ES-6036	\$1,893	\$1,990	\$2,152	180
36"	72"	8ES-7236	\$1,688	\$2,370	\$2,532	192
48"	48"	8ES-4848	\$2,024	\$2,134	\$2,283	192

Series 800 4-Leg Parsons Table (Indicate desired height after model number)

Solid Colors
Mitered Corner
Construction

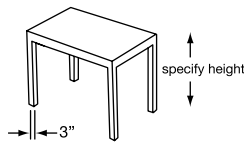

D	W	Parson #	Zone 0	Zone 1	Zone 2	WT
12"	48"	8PS-4812	\$504	\$601	\$763	40
12"	60"	8PS-6012	\$570	\$667	\$828	45
12"	72"	8PS-7212	\$701	\$798	\$959	50
12"	84"	8PS-8412	\$832	\$929	\$1,090	55
18"	48"	8PS-4818	\$741	\$838	\$998	50
18"	60"	8PS-6018	\$753	\$851	\$1,012	60
18"	72"	8PS-7218	\$1,094	\$1,191	\$1,353	65
18"	84"	8PS-8418	\$1,303	\$1,400	\$1,562	72
24"	24"	8PS-2424	\$504	\$601	\$763	40
24"	36"	8PS-3624	\$701	\$798	\$959	50
24"	48"	8PS-4824	\$976	\$1,073	\$1,234	60
24"	60"	8PS-6024	\$1,225	\$1,322	\$1,484	70
24"	84"	8PS-8424	\$1,762	\$1,859	\$2,021	90
30"	30"	8PS-3030	\$819	\$916	\$1,078	51
30"	48"	8PS-4830	\$1,252	\$1,348	\$1,509	70
30"	60"	8PS-6030	\$1,608	\$1,728	\$1,890	82
30"	72"	8PS-7230	\$2,077	\$2,174	\$2,348	95
36"	36"	8PS-3636	\$1,094	\$1,191	\$1,353	65
36"	48"	8PS-4836	\$1,487	\$1,584	\$1,746	80
36"	60"	8PS-6036	\$1,893	\$1,990	\$2,152	95
36"	72"	8PS-7236	\$1,688	\$2,370	\$2,532	110
48"	48"	8PS-4848	\$2,024	\$2,134	\$2,283	100

NOTE: Specify required height("H) when ordering. Prices reflect up to 30" height.

31"H to 36"H add 12% to List Price

37"H to 42"H add 20% to List Price

Casters on tables smaller than 18"D x 60"W - **ADD \$290 to LIST**

Intermediate sizes available. Consult factory

Center drawers available. Consult factory.

SHIPS FULLY ASSEMBLED

Classic 39



Classic Collection



Edge

Series 600 Cube Tables - Indicate desired height after model number

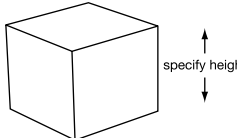

		12" - 18" High					
D	W	Model #	Zone 0	Zone 1	Zone 2	WT	
42"	42"	6F-4242	\$832	\$903	\$959	78	
36"	36"	6F-3636	\$662	\$732	\$789	63	
48"	30"	6F-3048	\$648	\$720	\$776	60	
30"	30"	6F-3030	\$544	\$614	\$670	54	
60"	24"	6F-2460	\$701	\$772	\$828	65	
48"	24"	6F-2448	\$597	\$667	\$723	55	
36"	24"	6F-2436	\$544	\$614	\$670	46	
24"	24"	6F-2424	\$426	\$496	\$553	38	
60"	18"	6F-1860	\$648	\$720	\$776	58	
48"	18"	6F-1848	\$570	\$641	\$697	50	
36"	18"	6F-1836	\$452	\$523	\$579	41	
24"	18"	6F-1824	\$347	\$418	\$474	36	
18"	18"	6F-1818	\$321	\$392	\$448	30	

NOTE: Without Recessed Base

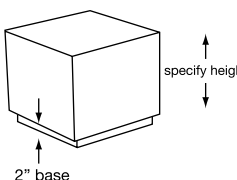

		12" - 18" High					
D	W	Model #	Zone 0	Zone 1	Zone 2	WT	
42"	42"	6B-4242	\$1,068	\$1,068	\$1,195	85	
36"	36"	6B-3636	\$872	\$998	\$1,026	68	
48"	30"	6B-3048	\$858	\$929	\$985	66	
30"	30"	6B-3030	\$741	\$811	\$867	59	
60"	24"	6B-2460	\$845	\$916	\$972	71	
48"	24"	6B-2448	\$793	\$863	\$920	61	
36"	24"	6B-2436	\$727	\$798	\$854	50	
24"	24"	6B-2424	\$544	\$614	\$670	42	
60"	18"	6B-1860	\$819	\$889	\$947	64	
48"	18"	6B-1848	\$728	\$798	\$854	55	
36"	18"	6B-1836	\$648	\$720	\$776	44	
24"	18"	6B-1824	\$504	\$576	\$632	40	
18"	18"	6B-1818	\$466	\$536	\$592	32	

NOTE: With Recessed Base

Optional: (In lieu of standard black)

	Model #	Price
Chrome Recess Base	CRB	\$136
Brass Recess Base	BRB	\$136

NOTE: Specify required height("H) in description when ordering. Prices reflect up to 18" high.

19"H to 24"H add 15% to List Price

25"H to 30"H add 20% to List Price

Intermediate sizes available. Consult factory

SHIPS FULLY ASSEMBLED

Classic 40



Classic Collection

Edge

Radius & Drum Table - Indicate desired height after model number

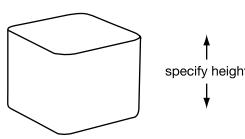

12" - 18" High						
D	W	Model #	Zone 0	Zone 1	Zone 2	WT
36"	36"	5F-3636	\$1,147	\$1,217	\$1,274	86
30"	30"	5F-3030	\$976	\$1,047	\$1,103	72
24"	36"	5F-2436	\$950	\$1,020	\$1,078	58
24"	24"	5F-2424	\$832	\$903	\$959	48
18"	24"	5F-1824	\$701	\$772	\$828	42
18"	18"	5F-1818	\$648	\$720	\$776	36

Without Recessed Base

SHIPS FULLY ASSEMBLED

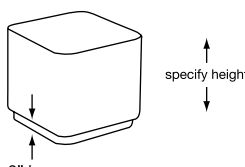

12" - 18" High						
D	W	Model #	Zone 0	Zone 1	Zone 2	WT
36"	36"	5B-3636	\$1,474	\$1,544	\$1,602	102
30"	30"	5B-3030	\$1,278	\$1,348	\$1,405	84
24"	36"	5B-2436	\$1,265	\$1,335	\$1,391	68
24"	24"	5B-2424	\$1,055	\$1,126	\$1,182	58
18"	24"	5B-1824	\$990	\$1,060	\$1,116	48
18"	18"	5B-1818	\$950	\$1,020	\$1,078	42

With Recessed Base - Black Standard

SHIPS FULLY ASSEMBLED

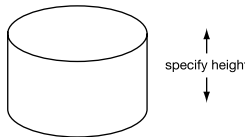

D	W	Model #	Zone 0	Zone 1	Zone 2	WT
36"	24"	7F-3624	\$1,159	\$1,231	\$129	66
30"	24"	7F-3024	\$1,028	\$1,100	\$1,156	58
23 1/2"	24"	7F-2324	\$766	\$838	\$894	52
20 1/2"	24"	7F-2024	\$741	\$811	\$867	48
17 1/2"	24"	7F-1724	\$701	\$772	\$828	44
36"	30"	7F-3630	\$1,618	\$1,689	\$1,746	72
30"	30"	7F-3030	\$1,343	\$1,415	\$1,471	65
23 1/2"	30"	7F-2330	\$1,016	\$1,086	\$1,143	58
20 1/2"	30"	7F-2030	\$990	\$1,060	\$1,116	53
17 1/2"	30"	7F-1730	\$950	\$1,020	\$1,078	48

Without Recessed Base

SHIPS FULLY ASSEMBLED

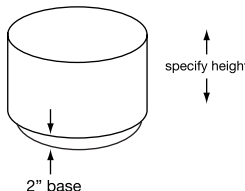

D	W	Model #	Zone 0	Zone 1	Zone 2	WT
36"	24"	7B-3624	\$1,514	\$1,584	\$1,640	74
30"	24"	7B-3024	\$1,343	\$1,415	\$1,471	66
23 1/2"	24"	7B-2324	\$1,016	\$1,086	\$1,143	61
20 1/2"	24"	7B-2024	\$937	\$1,007	\$1,064	58
17 1/2"	24"	7B-1724	\$885	\$955	\$1,012	54
36"	30"	7B-3630	\$1,998	\$2,069	\$2,126	82
30"	30"	7B-3030	\$1,645	\$1,715	\$1,771	74
23 1/2"	30"	7B-2330	\$1,278	\$1,348	\$1,405	67
20 1/2"	30"	7B-2030	\$1,199	\$1,269	\$1,326	62
17 1/2"	30"	7B-1730	\$1,147	\$1,217	\$1,274	58

With Recessed Base - Black Standard

SHIPS FULLY ASSEMBLED

Note: Intermediate sizes available. Consult factory.

	Price
	Model #
Chrome Recess Base	CRB \$147
Brass Recess Base	BRB \$147

Note: Pricing reflects up to 18" High. Specify required height ("H) in product description when ordering. 19" high to 24" add 15% to list price.

Classic 41



Triangle & Radius Triangle Tables

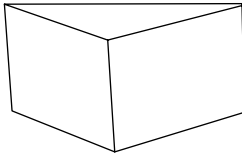

		18" High				
D	W	Model#	Zone 0	Zone 1	Zone 2	WT
16"	16"	TR16-F	\$544	\$614	\$670	28
18"	18"	TR18-F	\$531	\$601	\$658	30
24"	24"	TR24-F	\$610	\$680	\$736	38
30"	30"	TR30-F	\$701	\$772	\$828	54
36"	36"	TR36-F	\$793	\$863	\$920	63
42"	42"	TR42-F	\$924	\$995	\$1,051	78

Without Recessed Base

SHIPS FULLY ASSEMBLED

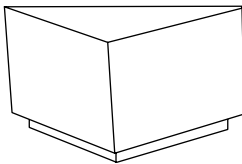

		18" High				
D	W	Model#	Zone 0	Zone 1	Zone 2	WT
16"	16"	TR16-B	\$714	\$785	\$841	30
18"	18"	TR18-B	\$753	\$824	\$881	32
24"	24"	TR24-B	\$832	\$903	\$959	42
30"	30"	TR30-B	\$990	\$1,060	\$1,116	59
36"	36"	TR36-B	\$1,121	\$1,191	\$1,247	68
42"	42"	TR42-B	\$1,291	\$1,362	\$1,418	85

With Recessed Base
Black Standard

SHIPS FULLY ASSEMBLED

NOTE: On the above tables, 2 of the 3 corners are blunt

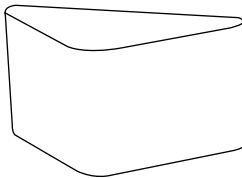

		18" High				
D	W	Model#	Zone 0	Zone 1	Zone 2	WT
18"	18"	RTR-18F	\$793	\$863	\$920	30
24"	24"	RTR-24F	\$910	\$982	\$1,038	38
30"	30"	RTR-30F	\$990	\$1,060	\$1,116	54
36"	36"	RTR-36F	\$1,107	\$1,178	\$1,244	63
42"	42"	RTR-42F	\$1,225	\$5,157	\$1,353	78

Without Recessed Base

SHIPS FULLY ASSEMBLED

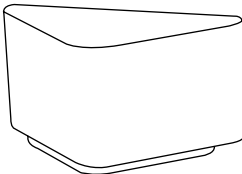

		18" High				
D	W	Model #	Zone 0	Zone 1	Zone 2	WT
18"	18"	RTR-18B	\$1,081	\$1,151	\$1,209	32
24"	24"	RTR-24B	\$1,199	\$1,269	\$1,326	42
30"	30"	RTR-30B	\$1,356	\$1,427	\$1,484	59
36"	36"	RTR-36B	\$1,487	\$1,558	\$1,615	68
42"	42"	RTR-42B	\$1,658	\$1,728	\$1,784	85

With Recess Base
Black Standard

SHIPS FULLY ASSEMBLED

Optional: (In lieu of standard black)

Chrome Recess Base	CRB	\$120
Brass Recess Base	BRB	\$120

NOTE: The above are nominal dimensions.
Intermediate sizes available. Consult Factory

Classic 42



Classic Collection

Edge

Series 400 Conference Table Tops with 1 1/4" Vinyl Bumper Edge

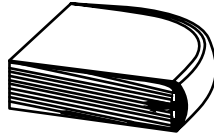

ROUND

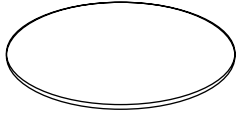

DIA	Model #	Zone 0	Zone 1	Zone 2	WT
60"	4TR60B	\$635	\$707	\$776	152
48"	4TR48B	\$439	\$510	\$579	103
42"	4TR42B	\$413	\$483	\$562	57
36"	4TR36B	\$347	\$418	\$488	40
30"	4TR30B	\$308	\$379	\$448	34

SQUARE

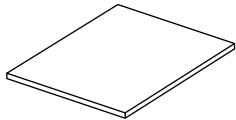

D	W	Model #	Zone 0	Zone 1	Zone 2	WT
42"	42"	4TS42B	\$321	\$392	\$461	60
36"	36"	4TS36B	\$216	\$287	\$357	43

RECTANGULAR

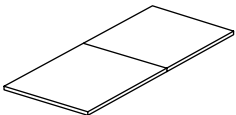

D	W	Model #	Zone 0	Zone 1	Zone 2	WT
48"	144"	4T84B-RT	\$1,815	\$1,846	\$1,955	225
48"	120"	4T80B-RT	\$1,081	\$1,255	\$1,220	180
48"	96"	4T86B-RT	\$1,003	\$1,073	\$1,143	145
42"	96"	4T26B-RT	\$889	\$893	\$959	130
42"	84"	4T24B-RT	\$701	\$772	\$841	101
36"	72"	4T62B-RT	\$544	\$614	\$684	78
36"	60"	4T60B-RT	\$439	\$510	\$579	67
30"	60"	4T00B-RT	\$360	\$431	\$501	53

RACETRACK

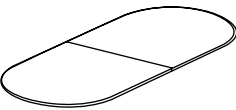

D	W	Model #	Zone 0	Zone 1	Zone 2	WT
48"	144"	4T84B-OV	\$1,815	\$1,886	\$1,955	225
48"	120"	4T80B-OV	\$1,474	\$1,544	\$1,615	180
48"	96"	4T86B-OV	\$1,134	\$1,205	\$1,274	145
42"	96"	4T26B-OV	\$1,055	\$1,126	\$1,195	130
42"	84"	4T24B-OV	\$963	\$1,034	\$1,103	101
36"	72"	4T62B-OV	\$741	\$811	\$881	78
30"	60"	4T00B-OV	\$675	\$0	\$0	67

BOAT SHAPE

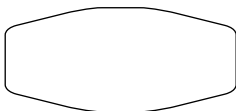

D	W	Model #	Zone 0	Zone 1	Zone 2	WT
48"	144"	4T84B-BT	\$2,117	\$2,187	\$2,257	225
48"	120"	4T80B-BT	\$1,303	\$1,375	\$1,444	180
48"	96"	4T86B-BT	\$1,121	\$1,191	\$1,260	145
42"	96"	4T26B-BT	\$1,028	\$1,100	\$1,169	130
42"	84"	4T24B-BT	\$937	\$1,007	\$1,078	101
36"	72"	4T62B-BT	\$714	\$785	\$854	78
30"	60"	4T00B-BT	\$622	\$693	\$763	67

Note: All 120"W & 144"W tops will be in 2 -pieces with tight joint fastener

Classic 43



Classic Collection



Series 400 Conference Table Tops with 1 1/8" Self Edge

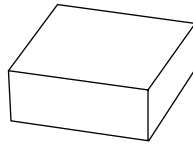

ROUND

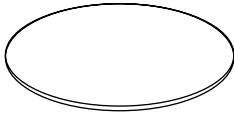

DIA	Model #	Zone 0	Zone 1	Zone 2	WT
60"	4TR60	\$648	\$720	\$789	152
48"	4TR48	\$452	\$523	\$592	103
42"	4TR42	\$413	\$483	\$553	57
36"	4TR36	\$386	\$457	\$527	40
30"	4TR30	\$347	\$418	\$488	34

SQUARE

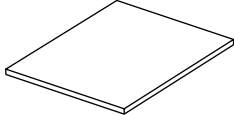

D	W	Model #	Zone 0	Zone 1	Zone 2	WT
42"	42"	4TS42	\$360	\$431	\$501	60
36"	36"	4TS36	\$282	\$352	\$422	43

RECTANGULAR

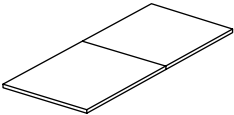

D	W	Model #	Zone 0	Zone 1	Zone 2	WT
48"	144"	4T84-RT	\$1,867	\$1,938	\$2,008	225
48"	120"	4T80-RT	\$1,094	\$1,165	\$1,234	180
48"	96"	4T86-RT	\$1,041	\$1,113	\$1,182	145
42"	96"	4T26-RT	\$859	\$929	\$998	130
42"	84"	4T24-RT	\$741	\$812	\$881	101
36"	72"	4T62-RT	\$570	\$641	\$710	78
36"	60"	4T60-RT	\$504	\$576	\$619	67
30"	60"	4T00-RT	\$400	\$470	\$539	53

RACE TRACK

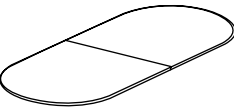

D	W	Model #	Zone 0	Zone 1	Zone 2	WT
48"	144"	4T84-OV	\$2,182	\$2,253	\$2,322	225
48"	120"	4T80-OV	\$1,356	\$1,427	\$1,496	180
48"	96"	4T86-OV	\$1,121	\$1,191	\$1,260	145
42"	96"	4T26-OV	\$1,055	\$1,126	\$1,195	130
42"	84"	4T24-OV	\$963	\$1,034	\$1,103	101
36"	72"	4T62-OV	\$753	\$824	\$894	78
30"	60"	4T00-OV	\$557	\$758	\$828	67

BOAT SHAPE

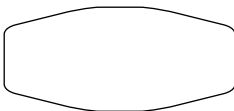

D	W	Model #	Zone 0	Zone 1	Zone 2	WT
48"	144"	4T84-BT	\$2,195	\$2,265	\$2,335	225
48"	120"	4T80-BT	\$1,369	\$1,400	\$1,471	180
48"	96"	4T86-BT	\$1,107	\$1,178	\$1,247	145
42"	96"	4T26-BT	\$1,028	\$1,100	\$1,169	130
42"	84"	4T24-BT	\$937	\$1,007	\$1,078	101
36"	72"	4T62-BT	\$741	\$811	\$881	78
30"	60"	4T00-BT	\$662	\$732	\$801	67

Note: All 120"W & 144"W tops will be in 2 -pieces with tight joint fastener

Classic 44



Classic Collection

Edge

Series 400 Conference Table Tops 1 1/8" Wood Edge

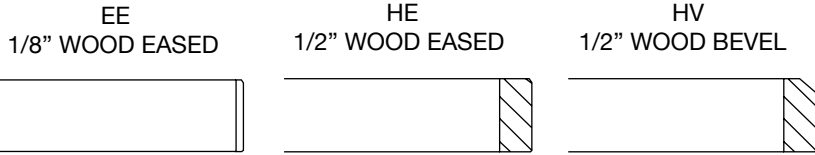

ROUND



	EE EDGE	HE EDGE	HV EDGE	Zone 0	Zone 1	Zone 2	WT
DIA	Model #	Model #	Model #				
60"	W4TR60B-EE	W4TR60MP-HE	W4TR60O-HV	\$1,777	\$1,990	\$2,237	152
48"	W4TR48B-EE	W4TR48MP-HE	W4TR48O-HV	\$1,291	\$1,445	\$1,618	103
42"	W4TR42B-EE	W4TR42MP-HE	W4TR42O-HV	\$1,120	\$1,254	\$1,405	57
36"	W4TR36B-EE	W4TR36MP-HE	W4TR36O-HV	\$902	\$1,010	\$1,131	40
30"	W4TR30B-EE	WRTR30MP-HE	W4TR30O-HV	\$793	\$888	\$995	34

SQUARE

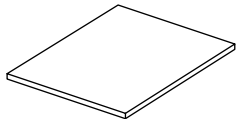

	EE EDGE	HE EDGE	HV EDGE	Zone 0	Zone 1	Zone 2	WT
D	Model #	Model #	Model #				
60"	W4TS42B-EE	W4TS42MP-HE	W4TS42O-HV	\$1,785	\$2,000	\$2,239	60
48"	W4TS36B-EE	W4TS36MP-HE	W4TS36O-HV	\$1,253	\$1,403	\$1,571	43

RECTANGULAR

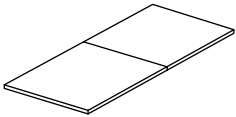

	EE EDGE	HE EDGE	HV EDGE	Zone 0	Zone 1	Zone 2	WT	
D	W	Model #	Model #	Model #				
48"	144"	W4T84B-RTEE	W4T84MP-RTHE	W4T84O-RTHV	\$3,203	\$3,588	\$4,019	225
48"	120"	W4T80B-RTEE	W4T80MP-RTHE	W4T80O-RTHV	\$2,726	\$3,054	\$3,421	180
48"	96"	W4T86B-RTEE	W4T86MP-RTHE	W4T86O-RTHV	\$2,225	\$2,492	\$2,792	145
42"	96"	W4T26B-RTEE	W4T26MP-RTHE	W4T26O-RTHV	\$2,225	\$2,492	\$2,792	130
42"	84"	W4T24B-RTEE	W4T24MP-RTHE	W4T24O-RTHV	\$2,095	\$2,346	\$2,629	101
36"	72"	W4T62B-RTEE	W4T62MP-RTHE	W4T62O-RTHV	\$1,383	\$1,549	\$1,735	78
36"	60"	W4T60B-RTEE	W4T60MP-RTHE	W4T60O-RTHV	\$1,181	\$1,322	\$1,481	67
30"	60"	W4T00B-RTEE	W4T00MP-RTHE	W4T00O-RTHV	\$1,025	\$1,148	\$1,286	53

RACETRACK

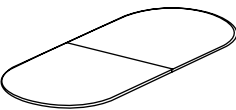

	EE EDGE	HE EDGE	HV EDGE	Zone 0	Zone 1	Zone 2	WT	
D	W	Model #	Model #	Model #				
48"	144"	W4T84B-OVEE	W4T84MP-OVHE	W4T84O-OVHV	\$4,221	\$4,728	\$5,295	225
48"	120"	W4T80B-OVEE	W4T80MP-OVHE	W4T80O-OVHV	\$3,583	\$4,012	\$4,493	180
48"	96"	W4T86B-OVEE	W4T86MP-OVHE	W4T86O-OVHV	\$2,890	\$3,236	\$3,625	145
42"	96"	W4T26B-OVEE	W4T26MP-OVHE	W4T26O-OVHV	\$2,890	\$3,236	\$3,625	130
42"	84"	W4T24B-OVEE	W4T24MP-OVHE	W4T24O-OVHV	\$2,771	\$3,103	\$3,475	101
36"	72"	W4T62B-OVEE	W4T62MP-OVHE	W4T62O-OVHV	\$1,981	\$2,218	\$2,484	78
30"	60"	W4T00B-OVEE	W4T00MP-OVHE	W4T00O-OVHV	\$1,880	\$2,106	\$2,359	67

BOAT SHAPE

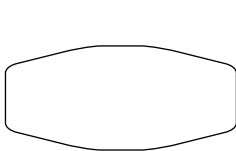

	EE EDGE	HE EDGE	HV EDGE	Zone 0	Zone 1	Zone 2	WT	
D	W	Model #	Model #	Model #				
48"	144"	W4T84B-BT	W4T84MP-BT	W4T84O-BT	\$4,221	\$4,728	\$5,295	225
48"	120"	W4T80B-BT	W4T80MP-BT	W4T80O-BT	\$3,583	\$4,012	\$4,493	180
48"	96"	W4T86B-BT	W4T86MP-BT	W4T86O-BT	\$2,890	\$3,236	\$3,625	145
42"	96"	W4T26B-BT	W4T26MP-BT	W4T26O-BT	\$2,890	\$3,236	\$3,625	130
42"	84"	W4T24B-BT	W4T24MP-BT	W4T24O-BT	\$2,771	\$3,103	\$3,475	101
36"	72"	W4T62B-BT	W4T62MP-BT	W4T62O-BT	\$1,981	\$2,218	\$2,484	78
30"	60"	W4T00B-BT	W4T00MP-BT	W4T00O-BT	\$1,880	\$2,106	\$2,359	67

NOTE: All 120"W & 144"W tops will be in 2 - pieces with tight joint fastener

Classic 45



Classic Collection

Edge

Series 400 Conference Table Tops 1 1/8" Wood Edge

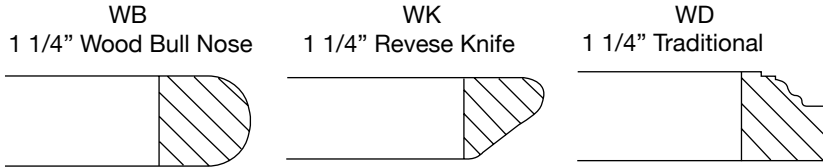

ROUND

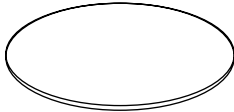

	WB EDGE		WK EDGE		WD EDGE					
DIA	Model #	Model #	Model #	Model #	Zone 0	Zone 1	Zone 2	WT		
60"	W4TR60W-WB	W4TR60M-WK	W4TR60CH-WD		\$2,038	\$2,283	\$2,556	152		
48"	W4TR48W-WB	W4TR48M-WK	W4TR48CH-WD		\$1,668	\$1,868	\$2,093	103		
42"	W4TR42W-WB	W4TR42M-WK	W4TR42CH-WD		\$1,423	\$1,594	\$1,784	57		
36"	W4TR36W-WB	W4TR36M-WK	W4TR36CH-WD		\$1,232	\$1,379	\$1,544	40		
30"	W4TR30W-WB	WRTR30M-WK	W4TR30CH-WD		\$1,131	\$1,267	\$1,419	34		

SQUARE

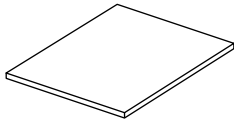

	WB EDGE		WK EDGE		WD EDGE					
D	Model #	Model #	Model #	Model #	Zone 0	Zone 1	Zone 2	WT		
60"	W4TS42W-WB	W4TS42M-WK	W4TS42CH-WE		\$2,007	\$2,248	\$2,518	60		
48"	W4TS36W-WB	W4TS36M-WK	W4TS36CH-WE		\$1,460	\$1,636	\$1,832	43		

RECTANGULAR

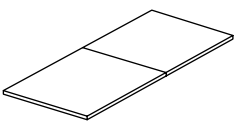

	WB EDGE		WK EDGE		WD EDGE						
D	W	Model #	Model #	Model #	Zone 0	Zone 1	Zone 2	WT			
48"	144"	W4T84W-RTWB	W4T84M-RTWK	W4T84CH-RTWD	\$3,446	\$3,860	\$4,323	225			
48"	120"	W4T80W-RTWB	W4T80M-RTWK	W4T80CH-RTWD	\$2,955	\$3,310	\$3,707	180			
48"	96"	W4T86W-RTWB	W4T86M-RTWK	W4T86CH-RTWD	\$2,456	\$2,751	\$3,081	145			
42"	96"	W4T26W-RTWB	W4T26M-RTWK	W4T26CH-RTWD	\$2,456	\$2,751	\$3,081	130			
42"	84"	W4T24W-RTWB	W4T24M-RTWK	W4T24CH-RTWD	\$2,297	\$2,573	\$2,882	101			
36"	72"	W4T62W-RTWB	W4T62M-RTWK	W4T62CH-RTWD	\$1,555	\$1,742	\$1,952	78			
36"	60"	W4T60W-RTWB	W4T60M-RTWK	W4T60CH-RTWD	\$1,337	\$1,499	\$1,679	67			
30"	60"	W4T00W-RTWB	W4T00M-RTWK	W4T00CH-RTWD	\$1,221	\$1,368	\$1,533	53			

RACETRACK

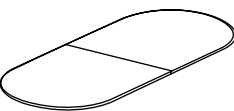

	WB EDGE		WK EDGE		WD EDGE						
D	W	Model #	Model #	Model #	Zone 0	Zone 1	Zone 2	WT			
48"	144"	W4T84W-OVWB	W4T84M-OVWK	W4T84CH-OVWD	\$4,475	\$5,012	\$5,614	225			
48"	120"	W4T80W-OVWB	W4T80M-OVWK	W4T80CH-OVWD	\$3,850	\$4,314	\$4,831	180			
48"	96"	W4T86W-OVWB	W4T86M-OVWK	W4T86CH-OVWD	\$3,086	\$3,456	\$3,870	145			
42"	96"	W4T26W-OVWB	W4T26M-OVWK	W4T26CH-OVWD	\$3,086	\$3,456	\$3,870	130			
42"	84"	W4T24W-OVWB	W4T24M-OVWK	W4T24CH-OVWD	\$2,833	\$3,172	\$3,552	101			
36"	72"	W4T62W-OVWB	W4T62M-OVWK	W4T62CH-OVWD	\$2,072	\$2,320	\$2,599	78			
30"	60"	W4T00W-OVWB	W4T00M-OVWK	W4T00CH-OVWD	\$1,901	\$2,129	\$2,384	67			

BOAT SHAPE

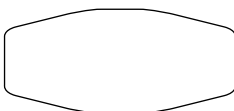

	WB EDGE		WK EDGE		WD EDGE						
D	W	Model #	Model #	Model #	Zone 0	Zone 1	Zone 2	WT			
48"	144"	W4T84W-BTWB	W4T84M-BTWK	W4T84CH-BTWD	\$4,475	\$5,012	\$5,614	225			
48"	120"	W4T80W-BTWB	W4T80M-BTWK	W4T80CH-BTWD	\$3,850	\$4,314	\$4,831	180			
48"	96"	W4T86W-BTWB	W4T86M-BTWK	W4T86CH-BTWD	\$3,086	\$3,456	\$3,870	145			
42"	96"	W4T26W-BTWB	W4T26M-BTWK	W4T26CH-BTWD	\$3,086	\$3,456	\$3,870	130			
42"	84"	W4T24W-BTWB	W4T24M-BTWK	W4T24CH-BTWD	\$2,833	\$3,172	\$3,552	101			
36"	72"	W4T62W-BTWB	W4T62M-BTWK	W4T62CH-BTWD	\$2,072	\$2,320	\$2,599	78			
30"	60"	W4T00W-BTWB	W4T00M-BTWK	W4T00CH-BTWD	\$1,901	\$2,129	\$2,384	67			

NOTE: All 120"W & 144"W tops will be in 2 -pieces with tight joint fastener

Classic 46



Metal Bases

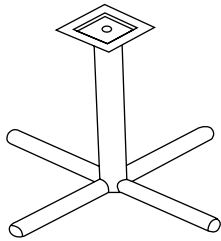

Finish	Top Capacity	Base Spread	Model #	Zone 0	Zone 1	Zone 2	WT
Chrome	42" Rd.	32" x 32"	5730-TC	\$638	\$694	\$759	24
Chrome	60" Rd.	39" x 39"	5736-TC	\$771	\$833	\$937	26
Black	42" Rd.	32" x 32"	5730-TB	\$603	\$666	\$716	24
Black	60" Rd.	39" x 39"	5736-TB	\$673	\$690	\$773	26

Cluster - 27 3/4" High

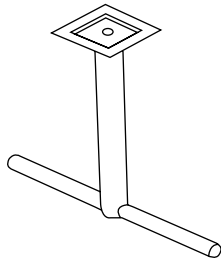

WT	Finish	Top Capacity	Base Spread	Model #	Zone 0	Zone 1	Zone 2
36	Chrome	36"D x 72"W	26"	5726-CC (pair)	\$621	\$696	\$772
42	Chrome	48"D x 96"W	32"	5736-CC* (pair)	\$649	\$727	\$813
36	Black	36"D x 72"W	26"	5726-CB (pair)	\$445	\$498	\$558
42	Black	48"D x 96"W	32"	5736-CB* (pair)	\$517	\$579	\$648

NOTE: Prices is for pair
Double Column base.*
Larger tops may need additional bases.

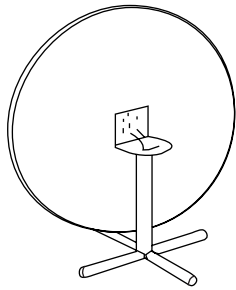

Finish	Top Capacity	Model #	Zone 0	Zone 1	Zone 2	WT
Chrome	48" Rd. or 42" Sq.	FTC2	\$890	\$957	\$1,023	26
Chrome	60" Rd. or 48" Sq.	FTC29	\$1,026	\$1,092	\$1,157	26
Black	48" Rd. or 42" Sq.	FTB2	\$879	\$937	\$1,010	26
Black	60" Rd. or 48" Sq.	FTB29	\$1,002	\$1,067	\$1,133	26

Flip Top Base Unit

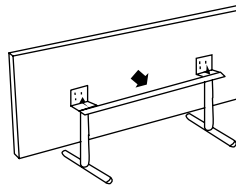

Finish	Top Capacity	Model #	Zone 0	Zone 1	Zone 2	WT
Chrome	36"D x 72"W	FBC26	\$1,199	\$1,269	\$1,340	105
Chrome	42"D x 72"W	FBC2	\$1,212	\$1,283	\$1,353	115
Black	36"D x 72"W	FBCB26	\$1,094	\$1,165	\$1,234	105
Black	42"D x 72"W	FBCB2	\$1,159	\$1,231	\$1,300	115

Flip Top Base Unit with Handle

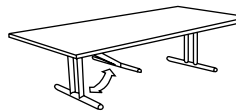

Finish	Top Capacity	Model #	Zone 0	Zone 1	Zone 2	WT
Chrome	24"D x 64"W to 96"W	FDC24	\$800	\$896	\$1,004	36
Chrome	30"D or 36"D x 64"W to 96"W	FDC30	\$832	\$931	\$1,042	36
Black	24"D x 64"W to 96"W	FDB24	\$629	\$706	\$790	36
Black	30"D or 36"D x 64"W to 96"W	FDB30	\$702	\$786	\$881	36

Folding Table Base - Price is for PAIR
NOTE: Number of Vertical Columns varies with base sizes.

IMPORTANT: FOLDING MECHANISM REQUIRES TABLE TO BE AT 64" LONG IN ORDER TO FOLD PROPERLY

Classic 47



Classic Collection

Edge

Laminate Bases

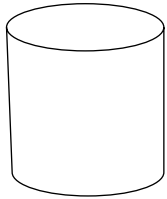

Top Capacity	D	H	Model #	Zone 0	Zone 1	Zone 2	WT
use w/ 60" Rd.	30"	27 3/4"	4C30	\$1,107	\$1,165	\$1,234	65
use w/ 48" Rd.	23 1/2"	27 3/4"	4C23	\$1,055	\$1,126	\$1,182	58
use w/ 42" Rd.	20 1/2"	27 3/4"	4C20	\$1,041	\$1,113	\$1,169	53
use w/ 36" Rd.	17 1/2"	27 3/4"	4C17	\$1,003	\$1,073	\$1,129	43

Cylinder Base
NOTE: Tops Unfinished

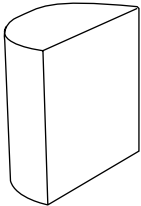

Top Capacity	D	H	Model #	Zone 0	Zone 1	Zone 2	WT
use w/ 42x 84 & 96 Oval Top Only	20 1/2"	27 3/4"	4HC20	\$753	\$824	\$881	30
use w/ 42x 84 & 120 Oval Top Only	23 1/2"	27 3/4"	4HC23	\$779	\$851	\$907	40
	30"	27 3/4"	4HC30	\$937	\$1,007	\$1,064	70
	36"	27 3/4"	4HC36	\$1,134	\$1,204	\$1,260	90

Half Cylinder Base
NOTE: Tops Unfinished

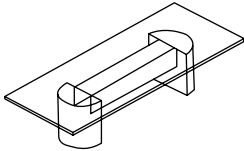

W	Model #	Zone 0	Zone 1	Zone 2	WT
24"	STR4HC24	\$1,936	\$2,169	\$2,429	240
30"	STR4HC30	\$2,217	\$2,483	\$2,781	350
36"	STR4HC36	\$2,568	\$2,876	\$3,221	425

Half Cylinder w/Stretcher

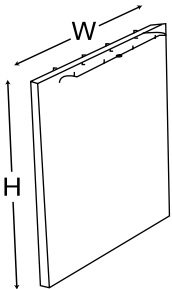

W	Model #	Zone 0	Zone 1	Zone 2	WT
24"	4PE24 (pair)	\$466	\$536	\$592	52
30"	4PE30 (pair)	\$517	\$589	\$645	72
36"	4PE36 (pair)	\$610	\$680	\$736	95

Base Panel Support

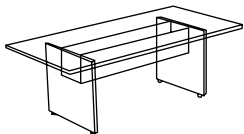

W	Model #	Zone 0	Zone 1	Zone 2	WT
24"	STR4PE24	\$1,375	\$1,540	\$1,725	208
30"	STR4PE30	\$1,468	\$1,645	\$1,843	288
36"	STR4PE36	\$1,556	\$1,743	\$1,953	380

End Panel w/Stretcher

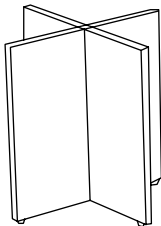

W	Model #	Zone 0	Zone 1	Zone 2	WT
24"	4CB24	\$622	\$693	\$749	52
30"	4CB30	\$688	\$758	\$815	72
36"	4CB36	\$753	\$824	\$881	95

Crossed Panel Base

Classic 48



Commercial Grade Cabinetry Cabinets, Counter, And Filler Specifications

- Healthcare
- Education
- Government
- Break rooms

Materials

Core Materials

1. Particle Board - Minimum Density 45 PCF, Industrial Grade 3 ply. max. moisture content 8%
2. Hardboard - Tempered smooth both sides.
3. Veneer Core Plywood

Face Materials

1. High Pressure Plastic Laminate: NEMA: LD3
 - a) General Purpose, 0.050 inch thick
 - b) Post Forming, 0.040 inch thick
 - c) Vertical Grade, 0.028 inch thick
 - d) Backer Sheet, 0.0020 inch thick

Edge Treatment Exposed and Semi -exposed Components

1. Body Members: Match face material, high pressure plastic laminate automatically applied using themofused glue.
2. Door and Drawer Fronts: Match face material, high pressure plastic laminate automatically applied using themofused glue.

Hardware

1. Hinges: High quality concealed cup hinge, 170 degrees opening and self closing.
2. Pulls: 4" on center wire pull. Brushed Aluminum standard finish.
3. Drawer Slides:
 - a) Cold rolled steel, epoxy coated, ball bearing roller slide.
 - b) Load Capacity, Typical Drawer 75 lbs. with 3/4 extensions.
4. Hardware for adjustable shelves
 - a) multiple holes 1 1/4 inch (32mm) on center with metal pins

Cabinet Construction Type

- A Flush Overlay

Core Material Thickness for Plastic Laminate Cad Components

- A Body Members, Rails: 3/4 inch thick particle board or veneer core plywood
- B Shelves: Particle Board or veneer core plywood
1. Spans up to 36 inches: 3/4 inch thick
 2. Interior shelves, white melamine with matching vinyl tape (Black available call customer service)
- C Backs: 1/4 inch hardboard, vinyl covered
- D Drawer Bottoms: 1/4 inch hardboard, vinyl covered
- E Drawer Sides, Backs, Sub fronts: 1/2" particleboard, min. density 50 pcf. vinyl wrapped
- F Drawer fronts, Doors: 3/4 particle board melamine interior, high pressure plastic laminate outside edges.

Surface Materials for Plastic Laminate

- A Exposed surfaces (other than edges): High pressure laminate 0.028" thick
- B Semi-exposed surfaces (other edges): High pressure laminate 0.028" thick, Clad Cabinets or low pressure laminate.
- C Countertops, Splashes, Edges: High pressure laminate 0.040" thick or 0.030" thick.

Assembly

- A. Casework shall be factory- assembled.

Classic 49



Classic Collection

Edge

Base Cabinets - 24" Depth - (Unfinished tops, sides, & backs)

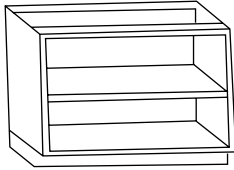

W	H	Model #	Zone 0	Zone 1	Zone 2	WT
24"	30"	H1024	\$675	\$772	\$932	81
30"	30"	H1030	\$872	\$969	\$1,129	101
36"	30"	H1036	\$1,068	\$1,165	\$1,326	122
24"	36"	K1024	\$741	\$838	\$998	92
30"	36"	K1030	\$950	\$1,047	\$1,209	115
36"	36"	K1036	\$1,159	\$1,257	\$1,431	138

No Door

SHIPS FULLY ASSEMBLED

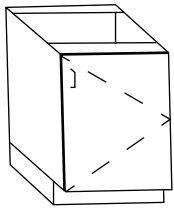

W	H	Model #	Zone 0	Zone 1	Zone 2	WT
16"	30"	H1116	\$466	\$562	\$723	54
18"	30"	H1118	\$531	\$627	\$789	61
24"	30"	H1124	\$741	\$838	\$998	81
16"	36"	K1116	\$517	\$614	\$776	61
18"	36"	K1118	\$544	\$680	\$841	69
24"	36"	K1124	\$806	\$903	\$1,064	92

One Door

SHIPS FULLY ASSEMBLED

NOTE: Right Hinged (Specify "LEFT Hinged)

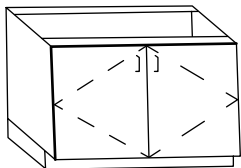

W	H	Model #	Zone 0	Zone 1	Zone 2	WT
30"	30"	H1230	\$950	\$1,047	\$1,209	101
36"	30"	H1236	\$1,159	\$1,257	\$1,418	122
30"	36"	K1230	\$1,028	\$1,126	\$1,287	115
36"	36"	K1236	\$1,252	\$1,348	\$1,509	138

Two Door

SHIPS FULLY ASSEMBLED

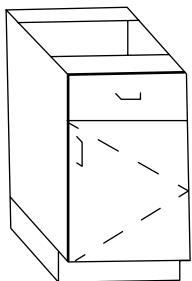

W	H	Model #	Zone 0	Zone 1	Zone 2	WT
16"	30"	H2316	\$400	\$497	\$658	54
18"	30"	H2318	\$675	\$772	\$932	61
24"	30"	H2324	\$1,055	\$1,151	\$1,313	81
16"	36"	K2316	\$728	\$824	\$985	61
18"	36"	K2318	\$806	\$903	\$1,064	69
24"	36"	K2324	\$1,121	\$1,217	\$1,378	82

Drawer Over Door

SHIPS FULLY ASSEMBLED

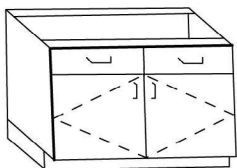

W	H	Model #	Zone 0	Zone 1	Zone 2	WT
30"	30"	H2430	\$1,007	\$1,453	\$1,615	101
36"	30"	H2436	\$1,231	\$1,741	\$1,902	122
30"	36"	K2430	\$1,448	\$1,544	\$1,729	115
36"	36"	K2436	\$1,749	\$1,846	\$2,008	138

Sink Base w/ Two Doors

SHIPS FULLY ASSEMBLED

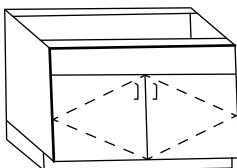

W	H	Model #	Zone 0	Zone 1	Zone 2	WT
30"	30"	K3124	\$832	\$929	\$1,090	101
36"	30"	K3130	\$1,028	\$1,126	\$1,287	122
30"	36"	K3136	\$937	\$1,362	\$1,522	115

NOTE: 30" H Units will have one adjustable shelf and 36" units will have two adjustable shelves. White interior finish standard. To have finish side on a cabinet specify RIGHT or LEFT and ADD \$135 to each LIST PRICE.

Classic 50



Classic Collection

Edge

Base Cabinets - 24" Depth - (Unfinished tops, sides, & backs)

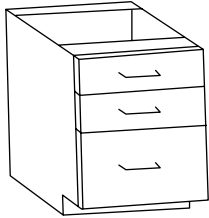

W	H	Model #	Zone 0	Zone 1	Zone 2	WT
16"	30"	H2616	\$937	\$1,034	\$1,195	97
18"	30"	H2618	\$1,055	\$1,151	\$1,313	109
24"	30"	H2624	\$1,448	\$1,544	\$1,706	127
30"	30"	H2630	\$1,842	\$1,938	\$2,099	145
36"	30"	H2636	\$2,221	\$2,318	\$2,479	163

Two 6" Drawers and One 12" Drawer
SHIPS FULLY ASSEMBLED

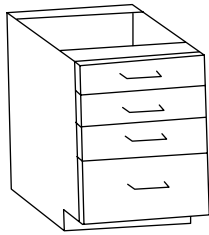

W	H	Model #	Zone 0	Zone 1	Zone 2	WT
16"	36"	K2716	\$1,107	\$1,204	\$1,365	108
18"	36"	K2718	\$1,252	\$1,348	\$1,509	125
24"	36"	K2724	\$1,711	\$1,806	\$1,968	135
30"	36"	K2730	\$2,153	\$2,252	\$2,414	156
36"	36"	K2736	\$2,614	\$2,711	\$2,872	176

Three 6" Drawers and One 12" Drawer
SHIPS FULLY ASSEMBLED

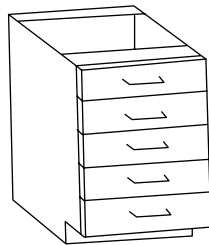

W	H	Model #	Zone 0	Zone 1	Zone 2	WT
16"	36"	K2816	\$1,252	\$1,348	\$1,509	108
18"	36"	K2818	\$1,396	\$1,493	\$1,653	125
24"	36"	K2824	\$1,854	\$1,952	\$2,112	135
30"	36"	K2830	\$2,300	\$2,396	\$2,558	156
36"	36"	K2836	\$2,759	\$2,855	\$3,016	184

Five 6" Drawers
SHIPS FULLY ASSEMBLED

NOTE: To have finished side on cabinet specify RIGHT or LEFT and **ADD \$165 to EACH LIST PRICE**

Base Cabinet Panels / Fillers

W	Model #	Zone 0	Zone 1	Zone 2	WT
2"	Q952	\$124	\$156	\$173	5
6"	Q956	\$151	\$183	\$199	7

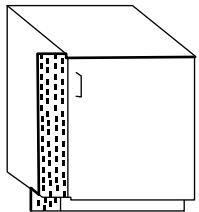

Filler Strip

Model #	Zone 0	Zone 1	Zone 2	WT
Q98CT	\$177	\$208	\$226	9

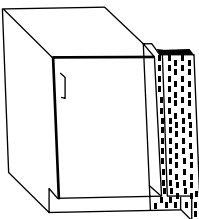

Corner Toe

NOTE: Panels and Fillers are for field installation

Classic 51



Classic Collection



Edge

Wall Cabinets - 12" Depth - (unfinished top and sides)

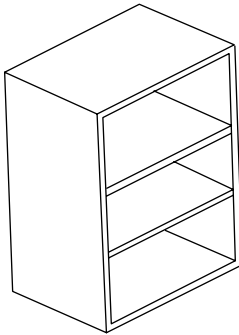

W	H	Model #	Zone 0	Zone 1	Zone 2	WT
16"	30"	D1016	\$347	\$445	\$605	37
18"	30"	D1018	\$400	\$496	\$658	41
24"	30"	D1024	\$531	\$627	\$789	55
30"	30"	D1030	\$688	\$785	\$945	69
16"	36"	F1016	\$373	\$470	\$632	44
18"	36"	F1018	\$386	\$483	\$645	50
24"	36"	F1024	\$622	\$720	\$881	60
30"	36"	F1030	\$779	\$876	\$972	75

No doors

SHIPS FULLY ASSEMBLED

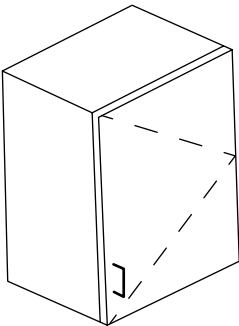

W	H	Model #	Zone 0	Zone 1	Zone 2	WT
16"	30"	D1116	\$426	\$523	\$684	37
18"	30"	D1118	\$479	\$576	\$736	41
24"	30"	D1124	\$675	\$772	\$932	55
16"	36"	F1116	\$466	\$562	\$723	44
18"	36"	F1118	\$531	\$627	\$789	50
24"	36"	F1124	\$741	\$838	\$998	66

One Door

NOTE: Right Hinged (Specify "LEFT Hinged")

SHIPS FULLY ASSEMBLED

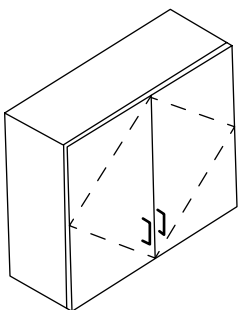

W	H	Model #	Zone 0	Zone 1	Zone 2	WT
30"	30"	D1230	\$859	\$955	\$1,116	69
36"	30"	D1236	\$1,041	\$1,138	\$1,300	83
30"	36"	F1230	\$950	\$1,047	\$1,209	83
36"	36"	F1236	\$1,172	\$1,269	\$1,431	99

NOTE: 30" H Units will have one adjustable shelf and 36" units will have two adjustable shelves. White interior finish standard. To have finish side on a cabinet specify RIGHT or LEFT and ADD \$179 to each LIST PRICE.

Classic 52



Classic Collection



Wall Cabinets - Panels/Fillers

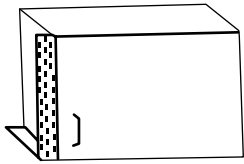

H	Model#	Zone 0	Zone 1	Zone 2	WT
30"	Q9030	\$111	\$143	\$173	5
36"	Q9036	\$124	\$156	\$186	7

Filler Strips - 2"W

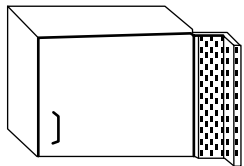

H	Model#	Zone 0	Zone 1	Zone 2	WT
30"	Q9330	\$124	\$156	\$186	7
36"	Q9336	\$138	\$168	\$226	9

Corner -2" x 2"

Counter Tops

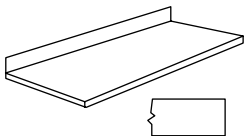

25"D Model#	Zone 0	Zone 1	Zone 2	WT
W25-B	\$124	\$156	\$186	13FT

Flat Edge w/ Backsplash 4"H

NOTE: Price is per foot

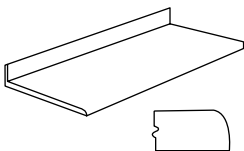

25"D Model#	Zone 0	Zone 1	Zone 2	WT
X25-B	\$164	\$195	\$226	13FT

Waterfall Edge w/ Backsplash 4"H

NOTE: Price is per foot

NOTE: Panels and Fillers are field installation.

Classic 53



Classic Collection

Edge

Tall Cabinets - 84" High (Unfinished Tops, Sides & back)

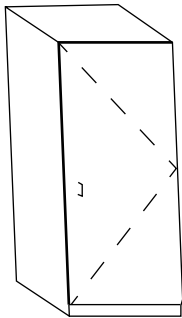

		24"D				
W	Model#	Zone 0	Zone 1	Zone 2	WT	
16"	P1116	\$2,273	\$2,370	\$2,532	92	
18"	P1118	\$2,614	\$2,711	\$2,872	104	
24"	P1124	\$3,505	\$3,602	\$3,764	138	

One Door, 1 Stationary Shelf, 4 adjustable Shelves
SHIPS FULLY ASSEMBLED

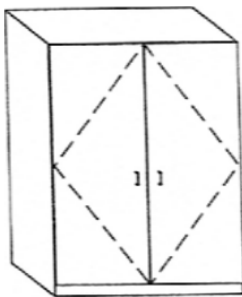

		24"D				
W	Model#	Zone 0	Zone 1	Zone 2	WT	
30"	P1230	\$3,545	\$3,641	\$3,803	173	
36"	P1236	\$4,266	\$4,362	\$4,523	207	

Two Door, 1 Stationary Shelf, 4 adjustable Shelves
SHIPS FULLY ASSEMBLED

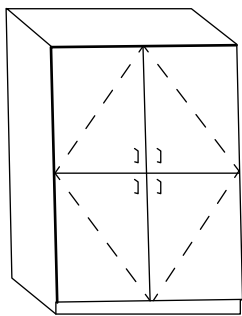

		24"D				
W	Model#	Zone 0	Zone 1	Zone 2	WT	
30"	P8330	\$3,636	\$3,733	\$3,895	173	
36"	P8336	\$4,344	\$4,441	\$4,602	207	

Double Doors over Double Doors, 1 Stationary Shelf, 4 adjustable shelves
SHIPS FULLY ASSEMBLED

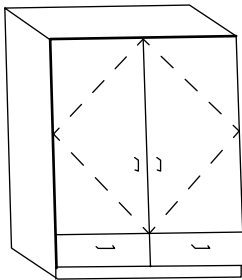

		24"D				
W	Model#	Zone 0	Zone 1	Zone 2	WT	
30"	P8530	\$4,121	\$4,218	\$4,379	173	
36"	P8536	\$4,973	\$5,070	\$5,231	207	

Doors Over Drawers
3 Adjustable Shelves
SHIPS FULLY ASSEMBLED

NOTE: All one door cabinets standard hinged right unless LEFT is specified.
Lock on door - Add \$109 to LIST PRICE
To have finished side on cabinet specify **LEFT** or **RIGHT**
Add \$229 to EACH LIST PRICE

Classic 54



Classic Collection

Edge

Series 1100 DVD Cabinets

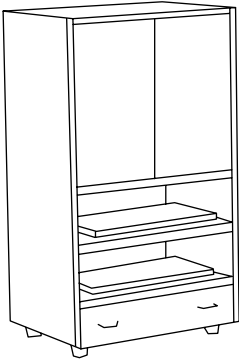

W	D	H	Model	Zone 0	Zone 1	Zone 2	WT
36"	25"	62 1/2"	11TV01	\$4,200	\$4,296	\$4,458	482

2 Pocket Doors/ 2 Shelves w/ Pull out Pad - 1 Bottom Drawer

NOTE: Inside Clearance on Cabinets

TOP: 28"W x 27" 23"D

BOTTOM: 33 1/2"W x 28 5/8"H x 23"D

SHIPS FULLY ASSEMBLED

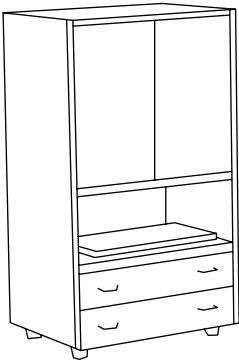

W	D	H	Model	Zone 0	Zone 1	Zone 2	WT
36"	25"	62 1/2"	11TV02	\$3,911	\$4,008	\$4,170	482

2 Pocket Doors/ 2 Shelves w/ Pull out Pad - 1 Bottom Drawer

NOTE: Inside Clearance on Cabinets

TOP: 28"W x 27" 23"D

BOTTOM: 33 1/2"W x 28 5/8"H x 23"D

SHIPS FULLY ASSEMBLED

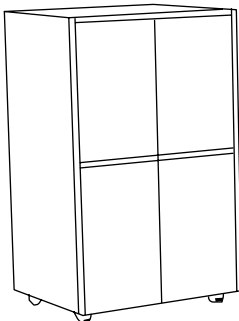

W	D	H	Model	Zone 0	Zone 1	Zone 2	WT
36"	25"	62 1/2"	11TV03	\$4,763	\$4,860	\$5,022	425

2 Pocket Doors/ 2 Shelves w/ Pull out Pad - 1 Bottom Drawer

2 Hinged Doors w/Adjustable Shelf Bottom

NOTE: Inside Clearance on Cabinets

TOP: 28"W x 27" 23"D

BOTTOM: 33 1/2"W x 28 5/8"H x 23"D

SHIPS FULLY ASSEMBLED

Classic 55

NOTE: LOCKS FOR EACH SET OF DOORS - ADD \$132 to LIST



Classic Collection



Edge

Visual Board and Lecterns

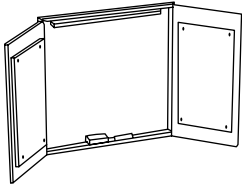

W	D	H	Model	Zone 0	Zone 1	Zone 2	WT
47 1/4"	5"	47 3/4"	VSB1	\$2,719	\$2,815	\$2,978	135

Visual Board w/porcelain dry ease surface and laminate doors with tackpanel on interior doors.

NOTE: Visual Board come standard with Dry Erase Makers, Eraser Kit, and PULL Down Screen. (Pull Down Screen not required, deduct \$322 from LIST PRICE)

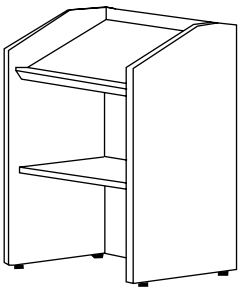

W	D	H	Model	Zone 0	Zone 1	Zone 2	WT
24"	18"	48"	11EC-F	\$1,265	\$1,362	\$1,522	102

Full Height Lectern

SHIPS FULLY ASSEMBLED

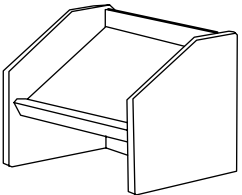

W	D	H	Model	Zone 0	Zone 1	Zone 2	WT
24"	18"	15"	11EC-T	\$662	\$995	\$1,159	102

Table Top Lectern

SHIPS FULLY ASSEMBLED

NOTE: Lecterns are vinyl bumper edge

Classic 56



Study Carrels

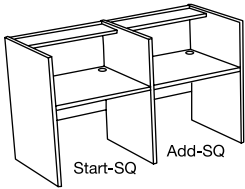

W	D	H	Model	Zone 0	Zone 1	Zone 2	WT
30"	36"	48"	START-SQ	\$1,749	\$1,846	\$2,011	216
30"	34 3/4"	48"	ADD-SQ	\$1,383	\$1,479	\$1,640	171

Starter Station w/ Add -On Square Profile

NOTE: Cable cut-outs standard **RIGHT & LEFT**

Starter Units are drilled & pinned on LEFT & RIGHT sides.

Work surface 29"High

Bookshelf is 4" from the top of carrel

Task light is available. Consult Customer Service

Ships Knocked Down

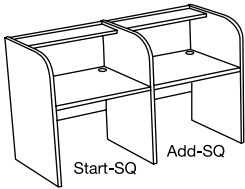

W	D	H	Model	Zone 0	Zone 1	Zone 2	WT
30"	36"	48"	START-RD	\$1,933	\$2,030	\$2,191	216
30"	34 3/4"	48"	ADD-RD	\$1,514	\$1,610	\$1,771	171

Starter Station w/ Add -On Square Profile

NOTE: Cable cut-outs standard **RIGHT & LEFT**

Starter Units are drilled & pinned on LEFT & RIGHT sides.

Work surface 29"High

Bookshelf is 4" from the top of carrel

Task light is available. Consult Customer Service

Ships Knocked Down

Classic 57



Optional Accessories for Curved Desks

Centered Drawer

Sized per unit - Must specify location - CD - \$200

NOTE: Pricing based ordering with a desk. If ordering a Center Drawer only consult Customer Service

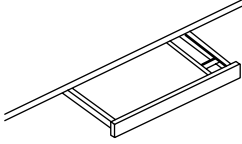

Storage Pedestal

Under curved desks 18" Deep model.

Under returns use 18" Deep model.

(Refer to page for pricing)

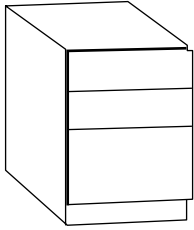

Cable Cut-Outs

Available in black only. 2 3/8" Diameter with cover.

1CO - \$66 ea

(Specify locations)

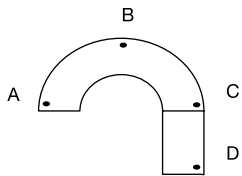

Optional Accessories for Reception Desk

Centered Drawer

Sized per unit - Must specify location - CD - \$200

NOTE: Pricing based ordering with a desk. If ordering a Center Drawer only consult Customer Service

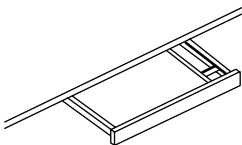

Box, Box, File

Pedestal mounted in desk.

Specify LEFT hand (LH) or **RIGHT** hand (RH) installation.

24"H x 22"D x 16"W with LOCK

BBF/L - \$839

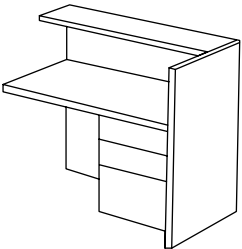



Optional Accessories for Reception Desk

File, File

Pedestal mounted in desk.
Specify **LEFT** hand (LH) or **RIGHT** hand (RH) installation.
24"H x 22"D x 16"W with LOCK
FF/L - \$839

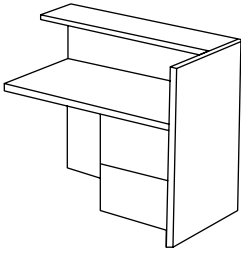

Box, File

Pedestal mounted in desk.
Specify **LEFT** hand (LH) or **RIGHT** hand (RH) installation.
18"H x 18"D x 16"W with LOCK
BF/L - \$670

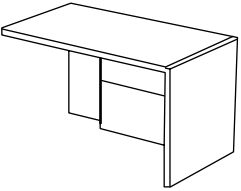

Task Light

If task light not required - TL \$237 (deduct)

Optional Accessories for Momentum Curved Desk

Centered Drawer

Sized per unit - Must specify location
CD - \$200 (Note: Pricing based ordering with a desk. If ordering a Center Drawer only consult Customer Service)

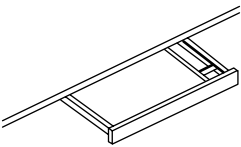

Storage Pedestal

Under curved desks 18" Deep model
Under returns use 18" Deep model.
(Refer to pages 24-25 for pricing)

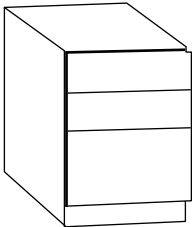

Cable Cut-Outs

Available in black only. 2 3/8" Diameter with cover. (Specify locations)
1CO - \$66 ea

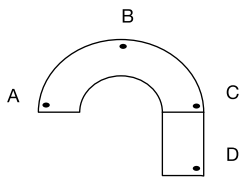



Classic Collection



Optional Accessories for Momentum Reception Desks

Center Drawer

Sized per unit - Must specify location - **CD - \$200**

NOTE: Pricing based ordering with a desk. If ordering a Center Drawer only consult Customer Service

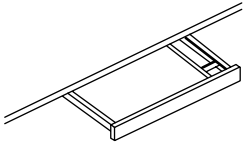

Box, Box, File

Pedestal mounted in desk.

Specify **LEFT** hand (LH) or **RIGHT** hand (RH) installation.
24"H x 22"D x 16"W with LOCK

BBF/L - \$1,197

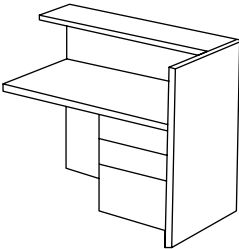

File, File

Pedestal mounted in desk.

Specify **LEFT** hand (LH) or **RIGHT** hand (RH) installation.
18"H x 18"D x 16"W with LOCK

BBF/L - \$1,197

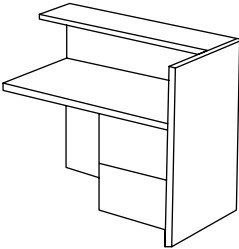

Box, File

LEFTRIGHT

BF/L - \$962

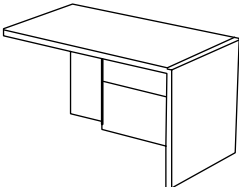

Task Light

If task light not required - TL \$200 (deduct)

Classic 60



Optional Accessories for Casegoods

Center Drawer

Sized per unit - Must specify location - **CD - \$200**

NOTE: Pricing based ordering with a desk. If ordering a Center Drawer only consult Customer Service
Cable Cut Out w/ Cover



2COL - \$66

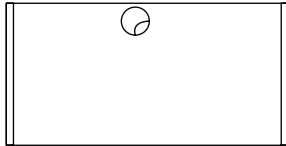

2CO - \$66



2COR - \$66

Master Key for Multiple Units

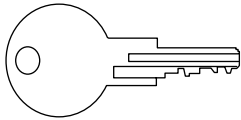

MK-\$52

Sliding Keyboard

SKS-\$253

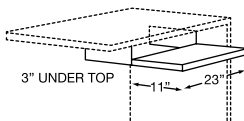

NOTE: If under return with pedestal, use 49" or larger return.
Not recommended for use with 26"H units.

Articulating Keyboard

AKB-\$654

The keyboard pad measures 9"D x 24"W

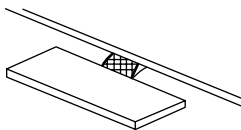

Optional Accessories for Casegoods

Printer Grommet

Specify location. Consult factory.

Shelf Available for Under Work Surface

Consult factory

Counter Weight for Laterals

CWT - \$133

Lock for Flipper Doors

2FL-\$111 (per door)

J-Track Molding

	Zone 0	Zone 1	Zone 2
JT-2" Lengths	\$76	\$85	\$91
JT-4 Lengths	\$99	\$111	\$121
JT-5"-Lengths	\$113	\$128	\$140
JT-6"-Lengths	\$131	\$145	\$160

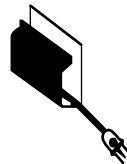

Tasklight

		Zone 0	Zone 1	Zone 2
TL - 24	24" Tasklight	\$251	\$282	\$308
TL - 48	48" Tasklight	\$391	\$441	\$480



TERMS

1. TERMS of PAYMENT

NET 15 days from date of shipment. Penalty 1/2% past due amount per month beyond 30 days from shipping date. Terms of payment will apply unless modified in writing by L.U.I.+PLUS.

2. PRICES

All pricing is LIST including delivery to one destination with a minimum. **Orders \$4,000.00 NET or more will ship freight PAID to one destination. Orders under \$4,000.00 NET will be charged a flat freight fee of \$300.00.** Pricing is for **DOCK to DOCK** delivery to a business. Any **CALL BEFORE / b4 DELIVERY CHARGES** from carriers will be add **\$25.00** to customer invoice. These published prices are effective by date shown and supercede previously publishing pricing. All pricing for shipments in the Continental United States delivered by the carrier of choice. Please consult factory for orders with destinations not shown on chart.

3. ORDER ENTRY

A. Written Orders must be accompanied by the customer's Purchase Order number and /or formal Purchase Order.

B. Orders will be accepted over FAX machine and or email as formal purchase orders. Confirmation not necessary. Duplicate orders not marked "**CONFIRMATION**" are the responsibility of the customer's. **FAX number: 1-(812) 482-1986.**

Order Email: luispang@psci.net.

C. Preliminary Orders - A preliminary order is a firm order submitted to L.U.I.+PLUS which lacks the complete information required to proceed with the order, such as: size, color of, or choice of material, etc. Preliminary orders will be governed by all standard Terms and Conditions of Sale. Preliminary Orders must include a requested ship date. We may acknowledge preliminary orders with a tentative ship date and at the time of acknowledgement will specify a date by which this information must be received in order to meet the acknowledged ship date. If this information is not received by the date specified, the order will be rescheduled to a later date and reacknowledge accordingly by L.U.I.+PLUS due to the non performance of the customer in supplying the information required by L.U.I.+PLUS will be subject to the pricing policy in effect at time of shipment.

D. Repair/Replacement orders for freight damaged parts or units must be ordered on a purchase order. No verbal orders taken. Pictures / Photos must be submitted.

E. Order cancellations are subject to a charge of 50% of the total NET bill of materials plus any charges that have accrued through manufacture or purchase of special materials. Should L.U.I.+PLUS agree to restock any QUICK SHIP ITEM, there will be a 60% restocking charge. Shipping point and date may be changed only if confirmed L.U.I.+PLUS at least one (1) week prior to schedule ship date. Storage charges will be assessed on customer delayed shipments.

F. Order Acknowledgements will be made by mail or fax or emailed to the customer. The customer will receive an acknowledgement. It is the customer's responsibility to review this acknowledgement carefully to see that it is correct in regard to the bill of materials, pricing, shipping address and in all other respects.

G. When the purchase order is received & model numbers & description do not match, model number will take precedent.

H. Revisions, Additions, and / or Deletions to an Order will be accepted if confirmed by L.U.I.+PLUS. Additions to in-house orders will be accepted at the same pricing as the original order and to the same address. Certain revisions to orders may affect delivery and pricing.

4. TAXES

All taxes are responsibility of the customer and are not included in our pricing. It is the customer's responsibility to provide L.U.I.+PLUS with appropriate TAX NUMBERS / TAX EXEMPT CERTIFICATE at time of order entry; otherwise tax will be applied, as required.

5. MINIMUM ORDERS

The minimum order that will be accepted is \$100.00 NET. Orders for less than \$100.00 NET will be billed \$100.00

6. CLAIMS

All merchandise is turned over to the transporting carrier in good condition and our liability for damages ceases at that time. Packing is transit tested. Shipments received short or damaged should be NOTED on the freight bill before signing for merchandise. All claims must be settled with the transportation company. File all claims promptly. L.U.I.+PLUS will not be responsible for any repairs resulting from transit damage.

7. PREEDENCE of TERMS AND CONDITIONS

These terms and conditions of the Price List and L.U.I.+PLUS Order Acknowledgement Conditions supersede and take precedence over the buyer's terms and conditions as stated on his/her purchase order, unless agreed otherwise in writing. The entering of an order to L.U.I.+PLUS shall acknowledge this concurrence.

8. PRODUCT CHANGES

In accordance with its policy of continuing product system improvement, L.U.I.+PLUS reserves the right to change, engineering, design or specifications without incurring obligation or liability and without further notice. Any product discontinued by L.U.I.+PLUS will be made available only for a period of one (1) year after date of product cancellation.

9. WEIGHTS

All weights are approximate & should be used only as a guide.

10 YEAR WARRANTY

Material and factory workmanship of standard L.U.I.+PLUS products are warranted for a perid of 10 years from the the date of shipment from our factory (unless otherwise stated in writing), provied they are installed in accordance with L.U.I.+PLUS recommended installation procedures and cleaning instructions.

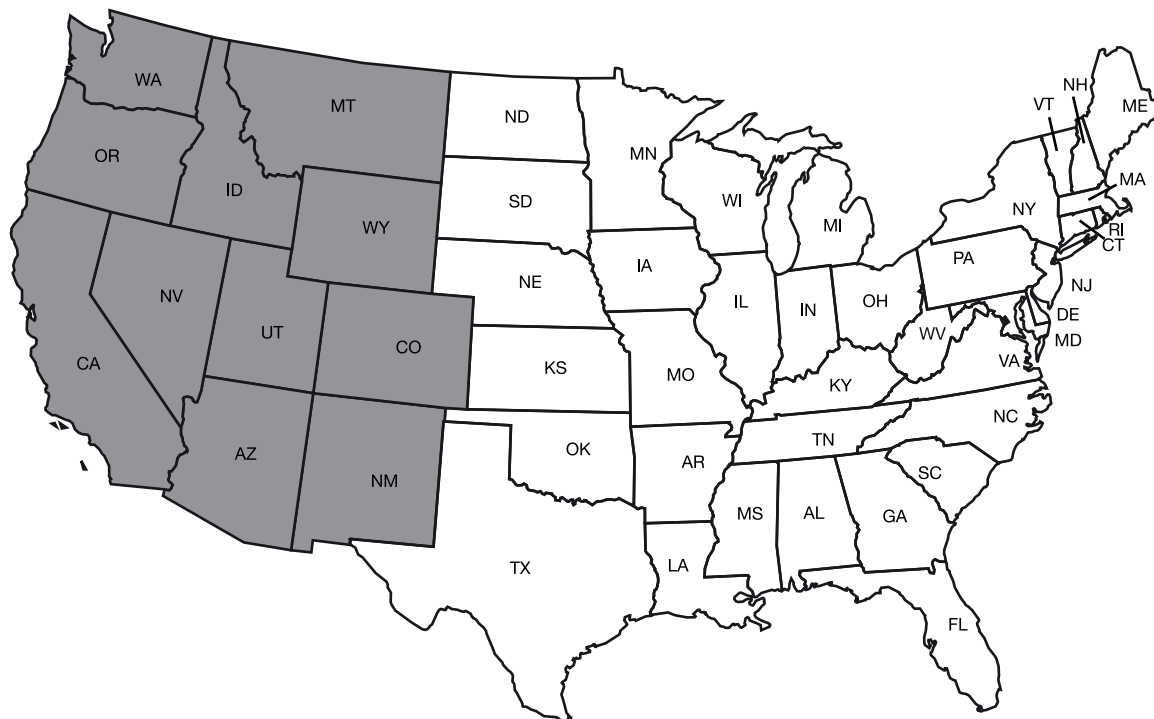

ZONE 1

ZONE 2

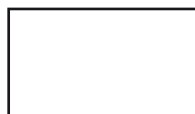

Zone 1

- Alabama
- Arkansas
- Connecticut
- Delaware
- Florida
- Georgia
- Illinois
- Indiana
- Iowa
- Kansas
- Kentucky
- Louisiana
- Maine
- Maryland
- Massachusetts
- Michigan
- Minnesota
- Missouri
- Mississippi

Zone 1

- Nebraska
- New Hampshire
- New Jersey
- New York
- North Carolina
- North Dakota
- Ohio
- Oklahoma
- Pennsylvania
- Rhode Island
- South Carolina
- South Dakota
- Tennessee
- Texas
- Virginia
- Washington D.C.
- Vermont
- West Virginia
- Wisconsin

Zone 2

- Arizona
- California
- Colorado
- Idaho
- Montana
- Nevada
- New Mexico
- Oregon
- Utah
- Washington
- Wyoming